

CE8000 SERIES

CUTTING PLOTTER

USER'S MANUAL

MANUAL NO.CE8000-UM-151



GRAPHTEC

Preface

Thank you for choosing a Graphtec CE8000 Series Cutting Plotter. The CE8000 Series Cutting Plotters employ a digital servo drive system to achieve high-speed and high-precision cutting. In addition to cutting marking film and other media, an CE8000 series plotter can also be used as a pen plotter. To ensure high cutting quality and optimal productivity, be sure to read this User's Manual thoroughly prior to use.

Notes on this Manual

- (1) No part of this publication may be reproduced, stored in a retrieval system, or transmitted, in any form or by any means, without the prior written permission of Graphtec Corporation.
- (2) The product specifications and other information in this manual are subject to change without notice.
- (3) While every effort has been made to provide complete and accurate information, please contact your sales representative or nearest Graphtec vendor if you find any unclear or erroneous information or wish to make other comments or suggestions.
- (4) Not with standing the stipulations in the preceding paragraph, Graphtec Corporation assumes no liability for damages resulting from either the use of the information contained herein or the use of the product.

Registered Trademarks

All names of companies, brands, logotypes, and products appearing in this manual are the trademarks or registered trademarks of their respective companies.

Copyright

This User's Manual is copyrighted by Graphtec Corporation.

About the operation method in the manual

- This manual explains operations using the touch panel.
You can also operate using the operation keys.
For details, see "2.7 How to Use Control Panel".

About the words and phrases in this text

- In this instruction manual, the word "plot" refers to operating the machine and using either the plotting pen or the cutter pen to cut.
- In this instruction manual, the word "media" refers to paper, roll media, sheet media, or marking film.

Prior to use

- Be sure to read the attached TO ENSURE SAFE AND CORRECT USE prior to use. Otherwise, it may cause an unexpected accident or fire.

Special Precautions on Handling Blades

Sharp cutter blades are used with this plotter. Handle the cutter blades and holders with care to prevent bodily injury.

Cutter Blades

Cutter blades are very sharp. While handling a cutter blade or cutter pen, be careful to avoid cutting your fingers or other parts of your body. Promptly return used blades to the cutter case provided.

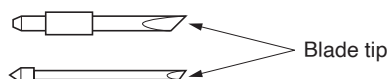

For the used blade, put it in the supplied cutter blade case and discard them in accordance with the local regulations.

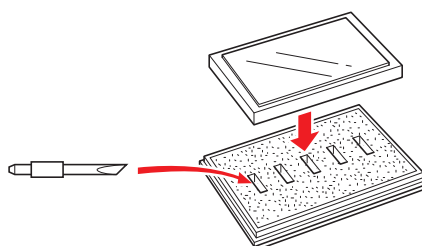

Cutter plungers

The tip consists of a sharp blade. Be sure not to extend it too far. Moreover, when you are not using the cutter plungers, make sure that the blade is fully retracted.

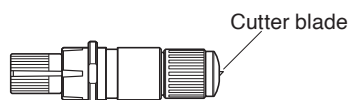

After Mounting the Cutter Plungers

After the power has been turned on, and during operation, do not touch the pen tip. It is dangerous.

After Turning on the Plotter

During the course of turning on the plotter, be sure to observe the following precautions. The tool carriage and loaded media may suddenly move during the cutting operation, immediately afterward and when setting the plotter's functions. Keep hands, hair, clothing and other objects out of the vicinity of the tool carriage, grit rollers and loaded media. To prevent operator injury and poor cutting results, be careful not to allow hands, hair, clothing or other foreign objects to become entangled with the tool carriage or loaded media while the plotter is operating.

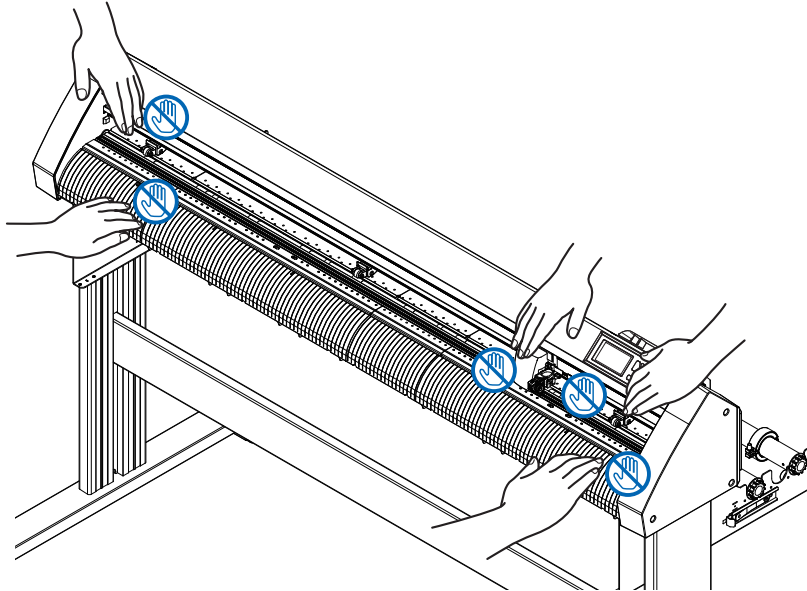

Machine Caution Label

The Caution Label is located on the machine. Be sure to observe all the cautions on the label.



Notes on the Stand

Be sure to use only the stand designed for the CE8000 Series with your CE8000 Series plotter. The use of a different stand may cause a plotter malfunction or bodily injury.

Notes on the basket (option)

Plotting/cutting longer than 2 m may affect the quality if the dedicated basket is not used. Be sure to use the dedicated basket.

Notes on the paper (media)

Please use the paper (media) in accordance with the following precautions.

- The paper is sensitive to temperature and humidity, and can start to stretch or contract immediately upon removal from the roll. Cutting/plotting the media immediately after taking it off causes it to stretch and may blur or cause deviations in the images.
- Please make sure to store the paper at the same environment (temperature/humidity) as this machine.
- Please always line up the edge of the paper.
Misalignment may cause paper skewing and mis-cuts.
Paper skewing can cause plotting deviation and cut offs.
- About the end of the roll media and the paper roll:
The cutting or plotting may differ depending on how the roll media ended or how the paper roll was stopped.
- About the paper roll:
This machine uses rolls with an internal diameter of 3 inches, or 76.2 mm. Mis-cuts or plotting deviations may occur if the paper roll is warped or has a larger internal diameter.
- About the use of thin media (70g/m² or less)
If the cutting speed is fast, there may be paper skewing. In that case, please lower the cutting speed. Especially when using in low humidity environment, please use lower cutting speed.

Precautions when using the curled media

- Especially upward curl will cause media jam even with weak curl.
- Please use uncurled media, or rework to make it curl weak downward to the extent that follows the plotter.

Notes on the specifications and accessories

Specifications and accessories depend on the sales area. For details, please contact your dealer.

WARNING

The United States Federal Communications Commission has specified that the following notice must be brought to the attention of users of this product.

FEDERAL COMMUNICATIONS COMMISSION RADIO FREQUENCY INTERFERENCE STATEMENT

NOTE: This equipment has been tested and found to comply with the limits for a Class A digital device, pursuant to part 15 of the FCC Rules. These limits are designed to provide reasonable protection against harmful interference when the equipment is operated in a commercial environment.

This equipment generates, uses, and can radiate radio frequency energy and, if not installed and used in accordance with the instruction manual, may cause harmful interference to radio communications. Operation of this equipment in a residential area is likely to cause harmful interference in which case the user will be required to correct the interference at his own expense.

USE SHIELDED CABLES

To comply with FCC Class A requirements, all external data interface cables and connectors must be properly shielded and grounded. Proper cables and connectors are available from GRAPHTEC's authorized dealers or manufacturers of computers or peripherals. GRAPHTEC is not responsible for any interference caused by using cables and connectors other than those recommended or by unauthorized changes or modifications to this equipment. Unauthorized changes or modifications could void the user's authority to operate the equipment.

Installation space

Please secure a space for installation as according to the below illustration.

⚠ CAUTION

Frontward and backward the machine, please take enough space for operation.

<CE8000-40>

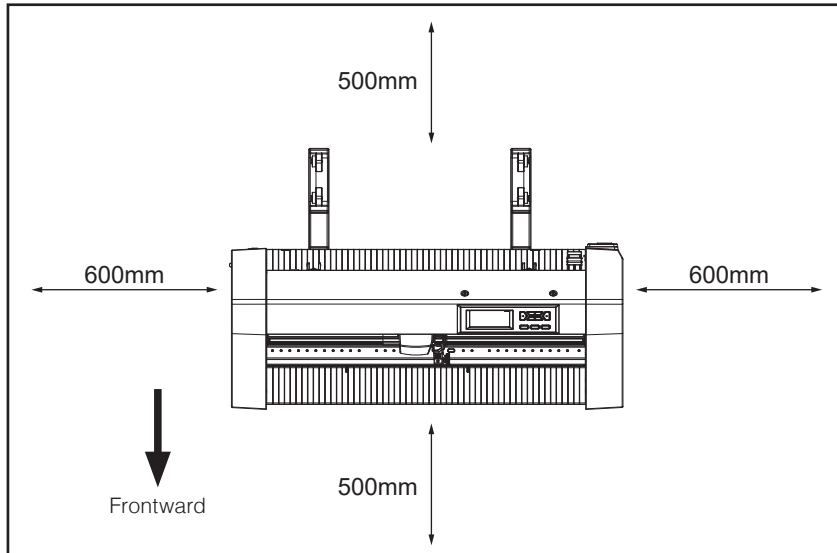

Seen from above

<CE8000-60/130>

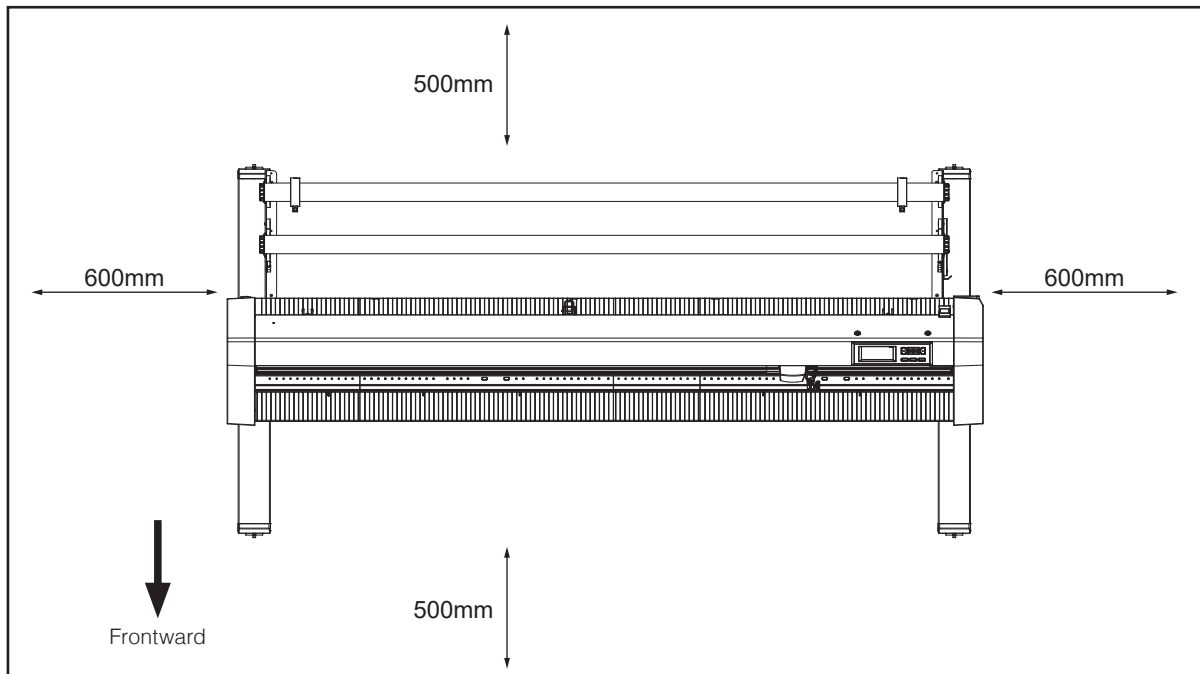

Seen from above

Selecting a power cable

Be sure to refer to the following tables if you wish to use a cable other than the one supplied as an accessory.

Table 1. 100 V to 120 V Power Supply Voltage Range

Plug Configuration	Plug Type	Supply Voltage Selector Settings	Reference Standards	Power Cable
	North America 125 V 10 A	100/120 V	ANSI C73.11 NEMA 5-15 UL498/817/62 CSA22.2 NO.42/21/49	UL Listed Type SJT No.18AWG×3 300 V, 10 A

Table 2. 200 V to 240 V Power Supply Voltage Range

Plug Configuration	Plug Type	Supply Voltage Selector Settings	Reference Standards	Power Cable
	Europe 250 V 10 A	200 V	CEE(7)VII IEC320 CEE13	TYPE: H05VV-F 3×1.0 mm ²
	UK 250 V 5 A	200 V	BS1363 BS4491 BS6500	TYPE: H05VV-F 3×1.0 mm ²
	Australia 250 V 10 A	200 V	AS3112 AS3109 AS3191	TYPE: OD3CFC 3×1.0 mm ²
	North America 250 V 15 A	200 V	ANSI C73.20 NEMA 6-15 UL 198.6	UL Listed Type SJT No.18AWG×3 300 V, 10 A
	Switzerland 250 V 6 A	200 V	SEV1011 SEV1004 SEV1012	TYPE: H05VV-F 3 × 0.75 mm ²
	China 250 V 6 A	200 V	GB15934 GB2099.1 GB1002 GB/T 5023.5	TYPE: H05VV-F 3×1.0 mm ²

Contents

Preface	I
Notes on this Manual	I
Registered Trademarks	I
Copyright	I
About the operation method in the manual	II
About the words and phrases in this text	II
Prior to use	II
Special Precautions on Handling Blades	III
Cutter Blades	III
Cutter plungers	III
After Mounting the Cutter Plungers	III
After Turning on the Plotter	IV
Machine Caution Label	IV
Notes on the Stand	IV
Notes on the basket (option)	IV
Notes on the paper (media)	V
Precautions when using the curled media	V
Notes on the specifications and accessories	V
WARNING	VI
FEDERAL COMMUNICATIONS COMMISSION RADIO FREQUENCY INTERFERENCE STATEMENT	VI
USE SHIELDED CABLES	VI
Installation space	VII
Selecting a power cable	VIII
 Chapter 1: Product Summary	
1.1 Checking the Accessories	1-2
Accessories	1-2
Dedicated accessories	1-3
1.2 Nomenclature	1-4
Front view: CE8000-40	1-4
Rear view: CE8000-40	1-5
Front view: CE8000-60	1-6
Rear view: CE8000-60	1-7
Front view: CE8000-130	1-8
Rear view: CE8000-130	1-9
1.3 Assembling	1-10
Mounting the Roll-medium tray	1-10
Mounting the stock shafts	1-11
1.4 Connecting to the Computer	1-13
When using USB/Wired LAN	1-13
When using wireless LAN	1-14

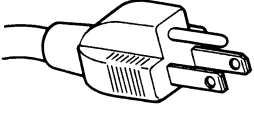
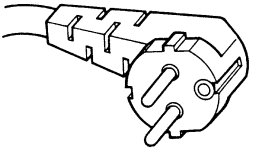
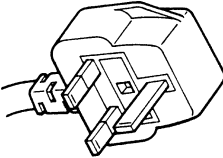
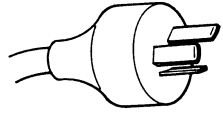
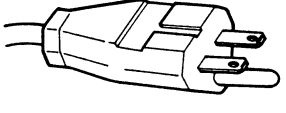
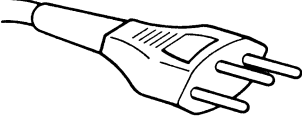
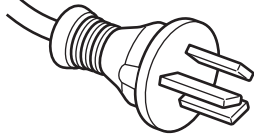
Chapter 2: Preparing to Cut

2.1 Preparation of Cutter Plunger	2-2
Cutter plunger nomenclature	2-2
Structure of cutter plunger	2-2
Adjusting the blade length	2-3
Blade application and features	2-3
2.2 Attaching a Tool	2-4
Attaching a tool	2-4
Removing the tool	2-6
2.3 Loading Media (Paper or Marking Film)	2-7
Loading roll media (CE8000-40)	2-7
Loading roll media (CE8000-60/130)	2-10
Loading sheet media (CE8000-40/60)	2-15
Loading sheet media (CE8000-130)	2-17
Carrier Sheet (for Affixing Media for Cutting)	2-19
Loading the Media	2-20
Effective Cutting Area	2-20
Mounting the Carrier Sheet Table	2-21
Setting method of carrier sheet (Carrier Sheet Table)	2-21
2.4 Aligning the Push Rollers	2-22
Aligning the push roller	2-22
When feeding long media (2 meters or more)	2-22
When feeding long media (2 meters or less)	2-23
When narrow media is used	2-23
Changing the hold-down force	2-24
Switching	2-24
2.5 About the Default Screen	2-25
2.6 Connecting to the Power	2-26
2.7 How to Use Control Panel	2-27
Operation key	2-27
Control panel screens	2-28
How to operate the control panel screen	2-29
Contents to be operated from the [☰] icon - Menu screen	2-30
Contents to be operated from the [▼] icon - CUT CONDITION screen	2-30
Contents to be operated from the [Q] icon - QUICK MENU screen	2-31
Contents to be operated from the [] icon - [CONTINUOUS OPERATION] START screen	2-31
2.8 Setting Feeding Method	2-34
2.9 Pre Feed of Media (Paper or Marking Film)	2-36
2.10 Selecting Tool Condition	2-37
Selecting the TOOL CONDITION number (Condition No.)	2-37
Setting the tool condition	2-38
Setting the tool	2-39
Tool offset setting	2-40
Setting the speed	2-41
Setting the force	2-42
Setting the acceleration	2-43
Setting tool No.	2-44

Adjust the blade length manually	2-46
2.11 Running Cutting Tests	2-47
Cutting test	2-47
To make 1 cut with set value	2-47
To make 3 cuts with set value and ± 1 of set value	2-48
Confirm the results of the cutting test.	2-50
Adjustment of Offset	2-50
Adjustment for Half Cutting	2-50
Adjustment for cutting out	2-50
Adjustment when using plotting pen	2-50
Adjust the blade length (Automatic Height Adjust)	2-51
2.12 Displaying Cutting Area	2-53

Chapter 3: Basic Operations

3.1 Raise or Lower the Tool	3-2
3.2 Move the Tool Carriage	3-3
Move in steps manually	3-3
Continuously move manually	3-3
Setting step movement distance	3-4
Move away the tool carriage.	3-5
Reset (Revert to the initial state when the power was turned on.)	3-6
3.3 Setting the Origin Point	3-7
When coordinate axes rotation are set.	3-8
When coordinate axes are rotated after origin point is set.	3-8
Setting origin point when HP-GL is set.	3-9
3.4 Setting the Cutting Direction	3-10
3.5 Stop Cutting	3-11
Pause and resume cutting	3-11
Stop cutting.	3-12

Chapter 4: Convenient Functions

4.1 Settings for Cutting	4-2
Setting cutting area	4-2
Setting cutting width (EXPAND)	4-4
Setting length of the page.	4-5
Setting mirror	4-6
Set the enlarge/shrink scale (Scale).	4-7
4.2 Copy (Duplicate Cutting)	4-9
When media change mode is OFF	4-9
When media change mode is ON	4-12
4.3 Panel Cutting	4-14

Chapter 5: ARMS (Advanced Registration Mark Sensing System)

5.1 Outline of ARMS	5-2
Shape (Pattern) of the Registration Mark and Origin Point	5-3
Scan Range Necessary to Detect the Registration Mark.	5-4

Positioning of the Media and the Registration Mark	5-6
Cutting area when adjusting the registration mark	5-6
Automatic detection of registration mark position	5-7
Media That Registration Mark Cannot be Detected	5-7
5.2 Setting and Adjustment of ARMS	5-8
Automatically adjust the registration mark sensor level	5-8
Manually adjust the registration mark sensor level	5-10
Test the registration mark sensor	5-12
Adjust for the registration mark scan position	5-14
Adjust after plotting the correction registration mark	5-14
Adjust using plotted adjustment registration mark	5-16
Set the registration mark automatic detection	5-19
Set speed of the registration mark scan	5-20

Chapter 6: Manual Position Adjust

6.1 Outline of Manual Position Adjust	6-2
Setting mark scan mode and number of adjustment marks	6-2
Adjust with 2 POINTS	6-2
Adjust with 3 POINTS	6-3
Adjust with 4 POINTS	6-3
6.2 Manual Position Adjust	6-4

Chapter 7: Settings Regarding Cutting Quality

7.1 Cutting the Corner of Thick Media Sharp	7-2
Outline of tangential mode	7-2
Setting the tangential mode	7-3
Setting the length of overcut	7-4
Setting of the Initial Down Force	7-5
7.2 Setting the Step Pass	7-7
7.3 Setting the Offset Angle	7-9
7.4 Setting the Distance Adjust	7-11
7.5 Setting Cut Line Pattern	7-13
7.6 Setting Initial Blade Control Position Adjust	7-16
7.7 Setting the blade control force	7-18
7.8 Setting Adjustment Between the Tools	7-20

Chapter 8: Settings Regarding Cutting Time

8.1 Sorting the Cutting Data	8-2
8.2 Perform Automatic Pre Feed When Cut Data is Received	8-3
8.3 Setting Feed Speed for Pre Feed	8-5
8.4 Setting the Moving Speed	8-6
8.5 Setting the Shortcut Move	8-8
8.6 Setting the Tool Up Height	8-9

Chapter 9: Settings Regarding Interface

9.1 Setting Interface	9-2
USB interface	9-2
Wireless LAN, Wired LAN interfaces	9-2
9.2 Connecting via wireless LAN	9-3
Access point setting	9-3
Set IP address, subnet mask and gateway	9-5
DHCP setting	9-8
Confirming the connection information	9-10
9.3 Connecting via wired LAN	9-11
IP address, subnet mask and gateway settings	9-11
DHCP setting	9-14
9.4 Clearing buffer memory	9-16

Chapter 10: Settings Regarding Operation Environment

10.1 Related to Menu Display	10-2
Display language setting (LANGUAGE SELECTION)	10-2
Display Length Unit Setting (LENGTH UNIT)	10-3
10.2 Related to sensor	10-4
Enabling/Disabling the media sensors	10-4
Enabling/Disabling the push roller sensors	10-5
10.3 Plotter Environment-related Settings	10-7
Fan suction setting	10-7
Media set assist settings	10-8
Enabling/Disabling the beep setting	10-9
LCD contrast setting	10-9

Chapter 11: Settings of Controls from Computer

11.1 Settings Related to Command Processing	11-2
Setting the command	11-2
Priority of cut condition selection	11-3
11.2 Related to GP-GL command	11-4
Setting the GP-GL step size	11-4
Enabling/Disabling the ':' and ';' commands	11-5
Moving the pen while raised or lowered in Response to the 'W' command	11-6
11.3 Related to HP-GL command	11-7
Model ID response	11-7
Circle command resolution	11-8

Chapter 12: Data Link

12.1 Select Connection Destination	12-2
12.2 Data Link with USB Memory	12-3
12.3 Output with a Bar Code	12-5
12.4 Communication Timeout	12-8
12.5 Skew Scanning	12-9

Chapter 13: Cutting with supplied application software

Chapter 14: Maintenance

14.1 Daily Maintenance	14-2
Daily maintenance	14-2
Storing the plotter	14-2
14.2 Replacing Cutter Blade	14-3
14.3 Cleaning the Cutter Plunger	14-4
14.4 Cutter Plunger Exchange	14-5
14.5 Setting the Alarm for Blade Wear Alarm	14-6
Alarm function ON/OFF, group, alarm distance settings	14-6
Blade wear clear setting	14-8

Chapter 15: Troubleshooting

15.1 Troubleshooting	15-2
When the plotter does not operate after turning the power on	15-2
When it does not work right	15-3
When the Cutting Result is Not Good	15-5
Error Messages in GP-GL Command Mode	15-6
Error Messages in HP-GL Command Mode	15-7
ARMS Error Messages	15-9
Other Error Messages	15-11
Caution Message	15-15
15.2 Check plotter information	15-16
15.3 Printing the Setting of the Plotter	15-17
15.4 Creating Test Pattern	15-19
15.5 Creating CUTTING PRO	15-21
15.6 Confirm the Plotting Data	15-22
15.7 Self Diagnostic Test	15-24
15.8 Reading the error message	15-26

Appendix

A.1 Main Specifications	A-2
A.2 Options and Supplies	A-3
Supplies	A-3
Options	A-3
A.3 External Dimensions	A-4
CE8000-40	A-4
CE8000-60	A-5
CE8000-130	A-6
A.4 Menu Tree	A-7
A.5 Initial Setting	A-10

Chapter 1: Product Summary



This chapter explains how to connect this machine to your computer.

SECTION IN THIS CHAPTER

- 1.1 Checking the Accessories*
- 1.2 Nomenclature*
- 1.3 Assembling*
- 1.4 Connecting to the Computer*

1.1 Checking the Accessories

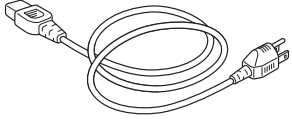
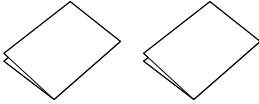
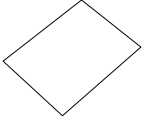
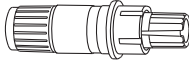
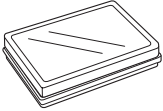
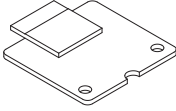
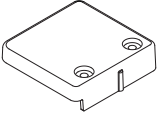
Accessories

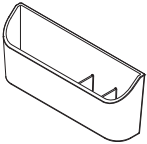
Item	Q'ty	Item	Q'ty
Power cable 	1 pc	SETUP MANUAL TO ENSURE SAFE AND CORRECT USE 	1 of each
WEB download guide 	1 sht.	Cutter plunger (PHP33-CB09N-HS) 	1 pc
Cutter blade (CB09UB (1P)) 	1 pc	Wireless LAN module 	1 pc
Wireless LAN module cover 	1 pc	Screws for wireless LAN module 	2 pcs
Accessory case 	1 pc		

* The accessory case has a magnet. Please attach it in a convenient location.

* In addition, various information may be attached.

* Accessories may vary depending on the sales area. For details, please contact the distributor where you purchased.

Dedicated accessories

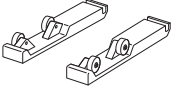
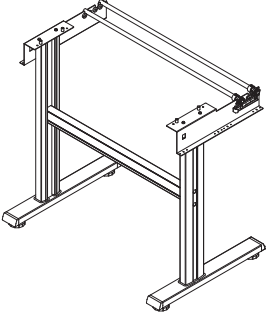
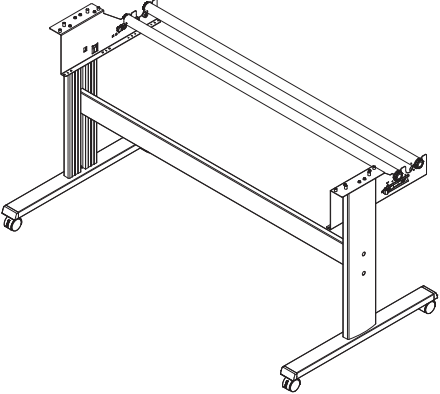
CE8000-40		CE8000-60		CE8000-130	
Item	Q'ty	Item	Q'ty	Item	Q'ty
Roll-medium tray 	1 set	Stand 	1 set	Stand 	1 set

1.2 Nomenclature

Front view: CE8000-40

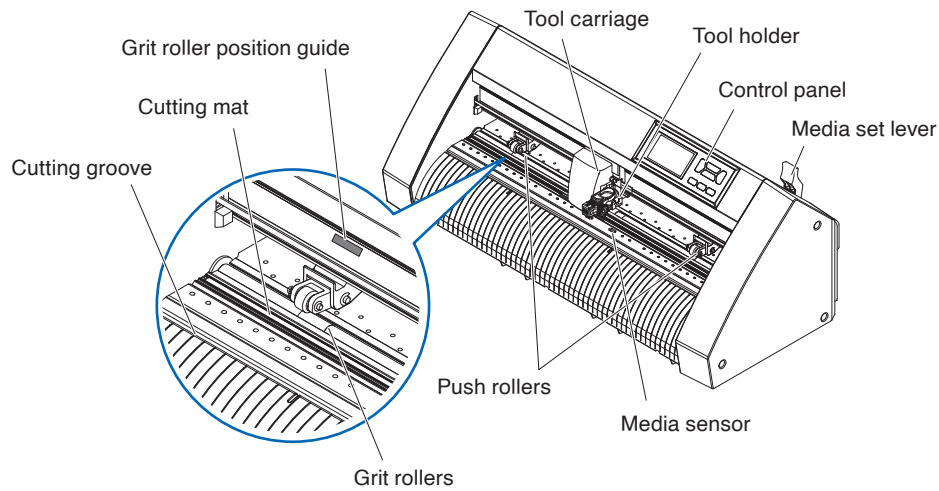

- Control panelUsed to access various plotter functions.
- Media set leverUsed to raise or lower the push rollers during the loading or unloading of media.
- Tool carriage.....Moves the cutter-pen or plotting pen across the media during cutting or plotting.
- Tool holder.....Holds the cutter-pen or plotting pen and moves it up or down.
- Media sensor.....Used to scan the leading edge of the media.
- Push rollersRollers that push the media against the grit rollers.
- Grit roller position guideA roller position guide is affixed to the front side of the rail, which shows the position of each grit roller. Use these alignment marks as an aid in locating the push rollers.
- Grit rollers.....Feeds the media back and forth.
- Cutting matThe cutter blade moves on this cutting mat.
- Cutting grooveUse this groove to cut out (die cut) or cross cut.

Rear view: CE8000-40

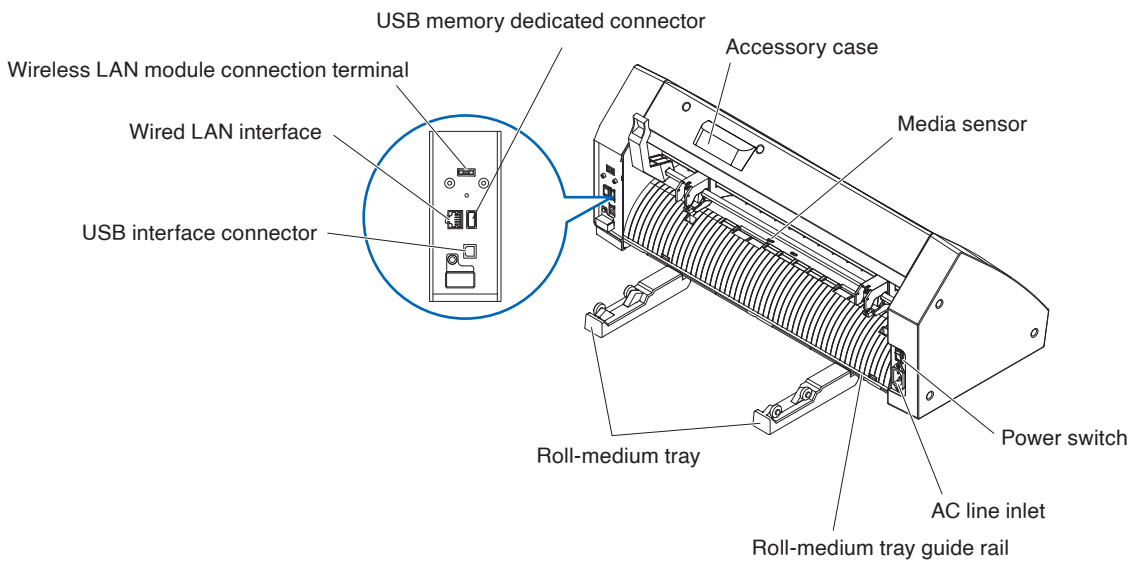

Power switchUsed to turn the plotter on and off.

AC line inletInlet where the power cable is connected.

Roll-medium trayA tray to set media in.

Roll-medium tray guide rail.....A rail to set the roll media tray in.

Accessory caseSpace for temporary storage of accessories such as cutter blades and cutter plungers.

* The accessory case has a magnet. Please attach it in a convenient location.

Media sensorUsed to scan the trailing edge of the media.

USB interface connectorUsed to connect the plotter to the computer with a USB interface cable.

Wireless LAN module connection terminal

.....This is the terminal for connecting the wireless LAN module to the plotter.

* A cover is attached to protect the terminals at the time of purchase.

Wired LAN interfaceThis connector is used when connecting this plotter via network (wired LAN).

* Wired LAN unit is factory-installed option.

USB memory dedicated connector

.....This is a dedicated connector for USB memory.

Front view: CE8000-60

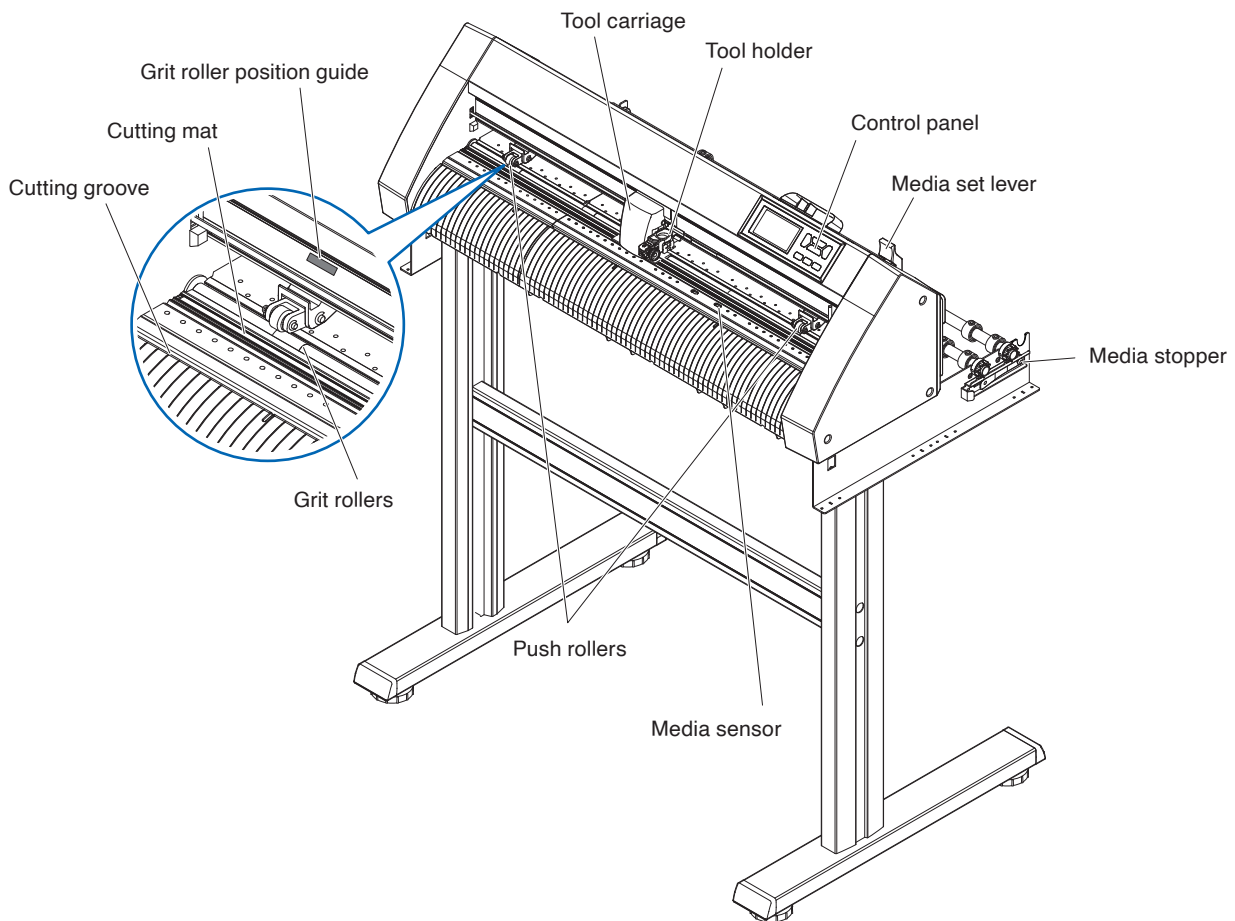

- Control panel**Used to access various plotter functions.
- Media set lever**Used to raise or lower the push rollers during the loading or unloading of media.
- Tool carriage**.....Moves the cutter-pen or plotting pen across the media during cutting or plotting.
- Tool holder**.....Holds the cutter-pen or plotting pen and moves it up or down.
- Media sensor**.....Used to scan the leading edge of the media.
- Push rollers**Rollers that push the media against the grit rollers.
- Media stopper**.....This stops the stock shaft from spinning when setting roll paper (media). It is utilized when pulling roll media straight out.
- Grit roller position guide**A roller position guide is affixed to the front side of the rail, which shows the position of each grit roller. Use these alignment marks as an aid in locating the push rollers.
- Grit rollers**.....Feeds the media back and forth.
- Cutting mat**.....The cutter blade moves on this cutting mat.
- Cutting groove**Use this groove to cut out (die cut) or cross cut.

Rear view: CE8000-60

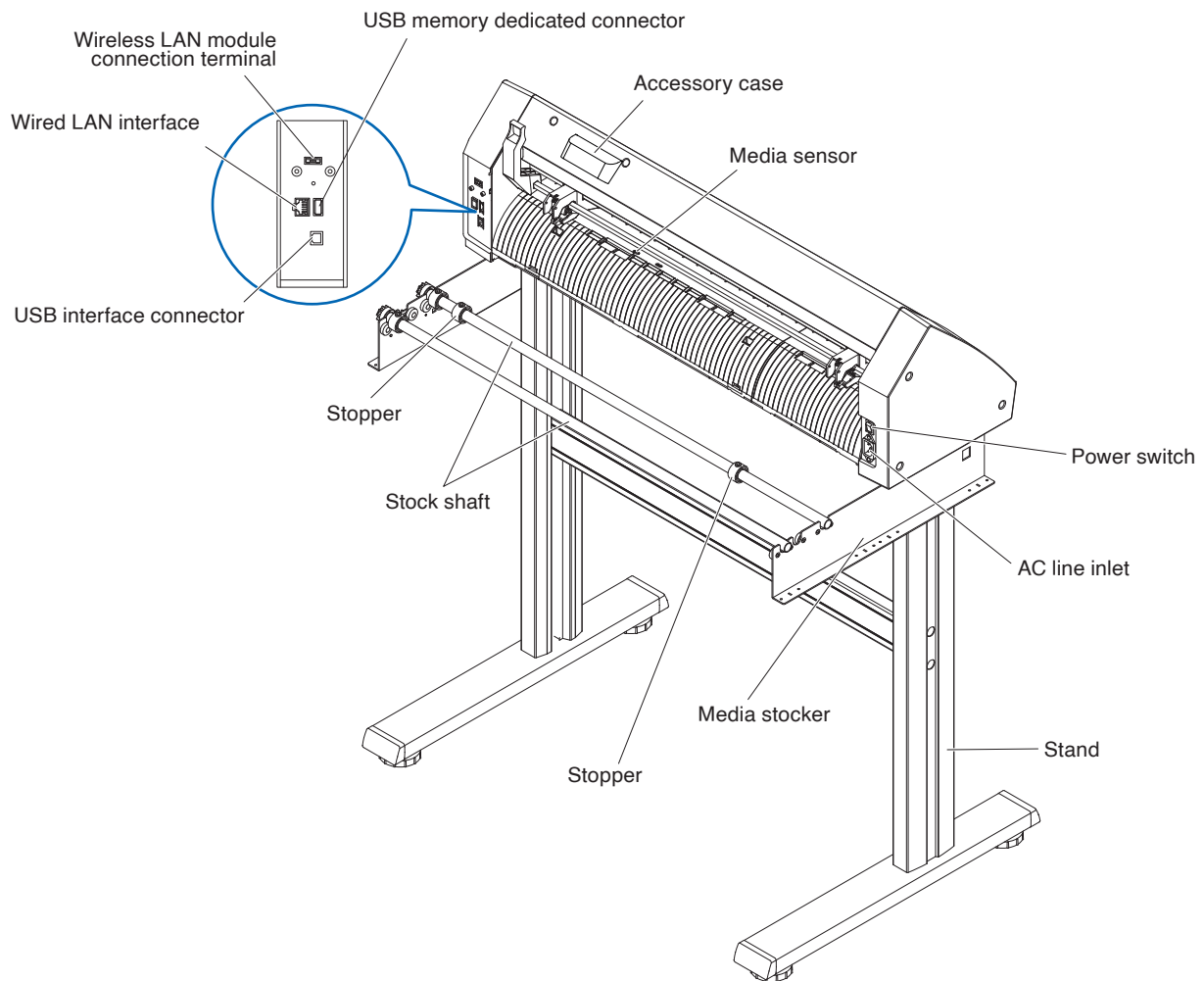

- Power switchUsed to turn the plotter on and off.
- AC line inletInlet where the power cable is connected.
- Media stockerA stock to set roll media in.
- Stock shaft.....A roller that takes in roll media.
- Stopper.....Keeps set roll media in place.
- StandA stand to put the machine on.
- Accessory caseSpace for temporary storage of accessories such as cutter blades and cutter plungers.
 * The accessory case has a magnet. Please attach it in a convenient location.
- Media sensor.....Used to scan the trailing edge of the media.
- USB interface connectorUsed to connect the plotter to the computer with a USB interface cable.
- Wireless LAN module connection terminal
This is the terminal for connecting the wireless LAN module to the plotter.
 * A cover is attached to protect the terminals at the time of purchase.
- Wired LAN interfaceThis connector is used when connecting this plotter via network (wired LAN).
 * Wired LAN unit is factory-installed option.
- USB memory dedicated connector
USB memory dedicated connector.

Front view: CE8000-130

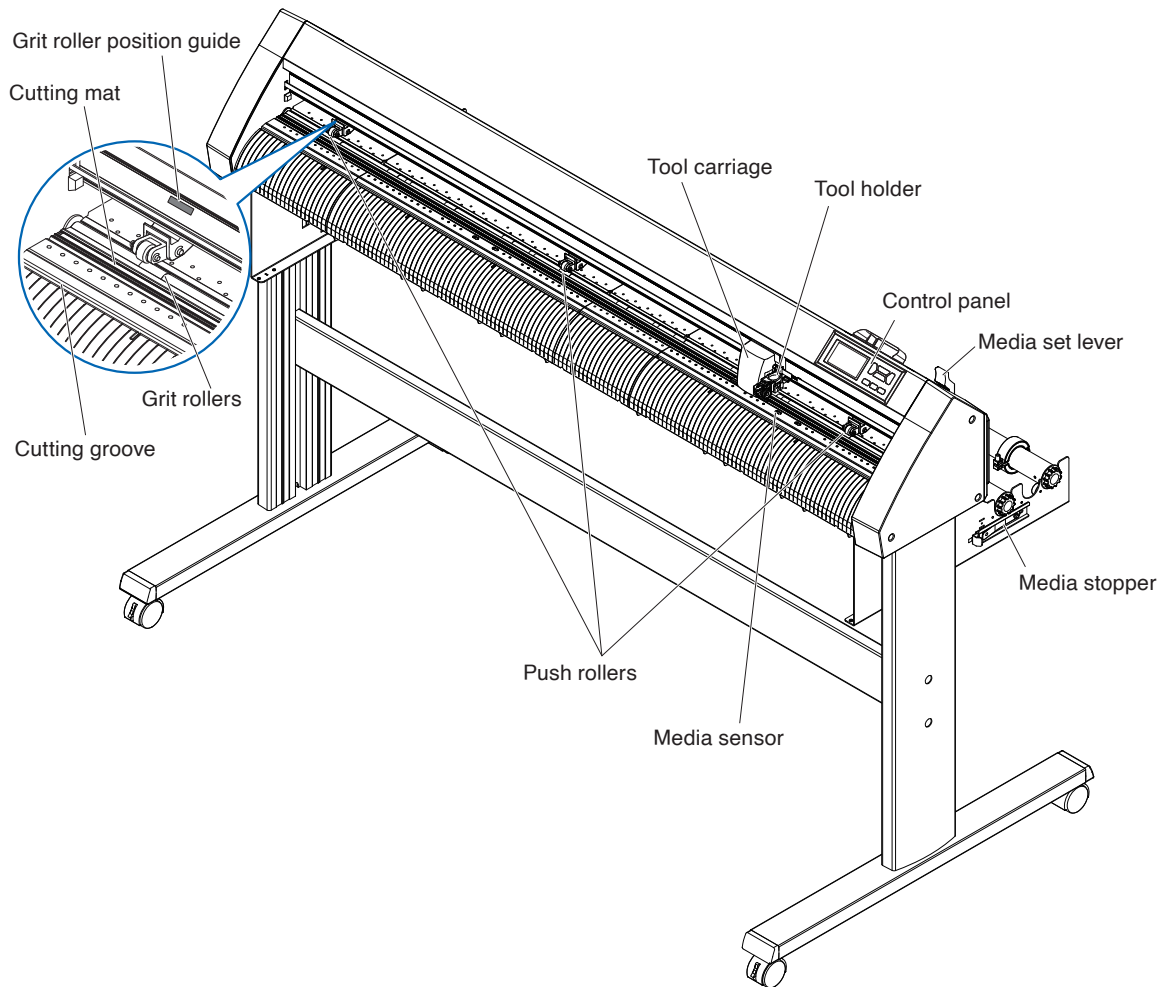

- Control panel**Used to access various plotter functions.
- Media set lever**Used to raise or lower the push rollers during the loading or unloading of media.
- Tool carriage**.....Moves the cutter-pen or plotting pen across the media during cutting or plotting.
- Tool holder**.....Holds the cutter-pen or plotting pen and moves it up or down.
- Media sensor**.....Used to scan the leading edge of the media.
- Push rollers**Rollers that push the media against the grit rollers.
- Media stopper**.....This stops the stock shaft from spinning when setting roll paper (media). It is utilized when pulling roll media straight out.
- Grit roller position guide**A roller position guide is affixed to the front side of the rail, which shows the position of each grit roller. Use these alignment marks as an aid in locating the push rollers.
- Grit rollers**.....Feeds the media back and forth.
- Cutting mat**The cutter blade moves on this cutting mat.
- Cutting groove**Use this groove to cut out (die cut) or cross cut.

Rear view: CE8000-130

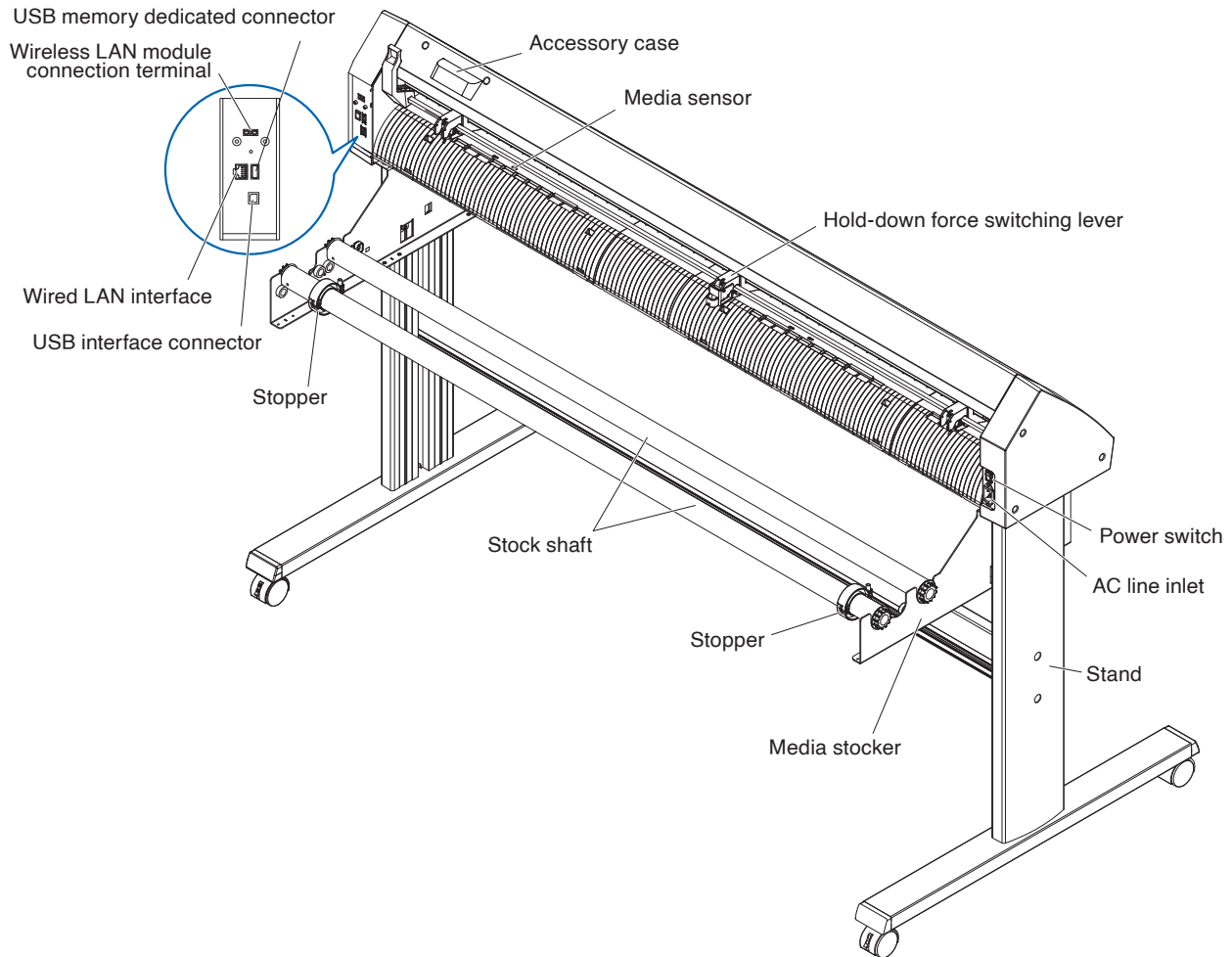

- Power switchUsed to turn the plotter on and off.
- AC line inletInlet where the power cable is connected.
- Hold-down force switching lever ..Switch the hold-down force of the push roller to two levels: medium and weak (OFF).
- Media stockerA stock to set roll media in.
- Stock shaft.....A roller that takes in roll media.
- Stopper.....Keeps set roll media in place.
- StandA stand to put the machine on.
- Accessory caseSpace for temporary storage of accessories such as cutter blades and cutter plungers.
 * The accessory case has a magnet. Please attach it in a convenient location.
- Media sensor.....Used to scan the trailing edge of the media.
- USB interface connectorUsed to connect the plotter to the computer with a USB interface cable.
- Wireless LAN module connection terminal
This is the terminal for connecting the wireless LAN module to the plotter.
 * A cover is attached to protect the terminals at the time of purchase.
- Wired LAN interfaceThis connector is used when connecting this plotter via network (wired LAN).
 * Wired LAN unit is factory-installed option.
- USB memory dedicated connector
USB memory dedicated connector.

1.3 Assembling

Mounting the Roll-medium tray

Mounting (CE8000-40)

1. Insert the roll-medium tray into the tray guide rail according to the media width you want to use. Make sure the rollers on the tray are on the outside on both sides.

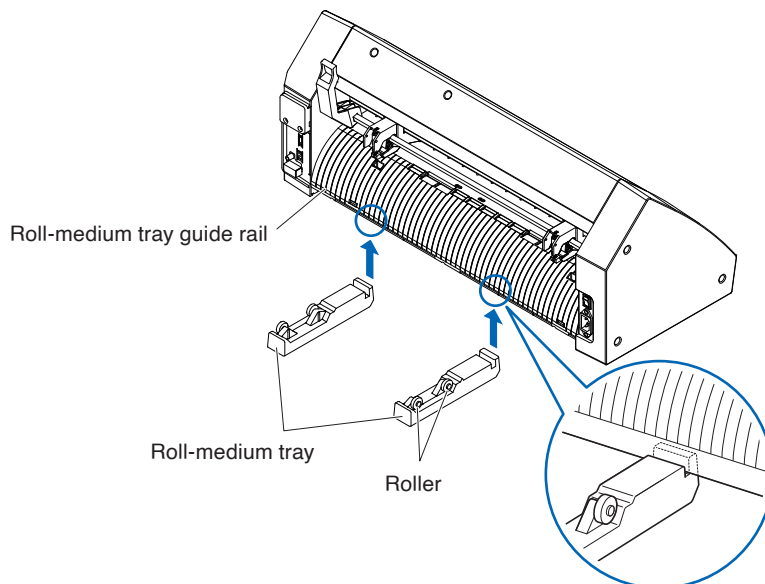

Mounting the stock shafts

Mounting (CE8000-60)

1. Set one stopper in the stock shaft. (Keep the stopper screws slightly loose.)

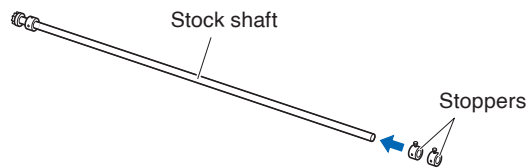

2. Put the side with the gear on the left side of the machine (looking from the back) and then slide the stock shaft into the media stocker. Slide the media stocker in so that it is bookended by the gear and the fixed stopper. Make sure the stock shaft touches the roller. Change the insertion position of the rear stock shaft according to the roll diameter of the media you want to use.

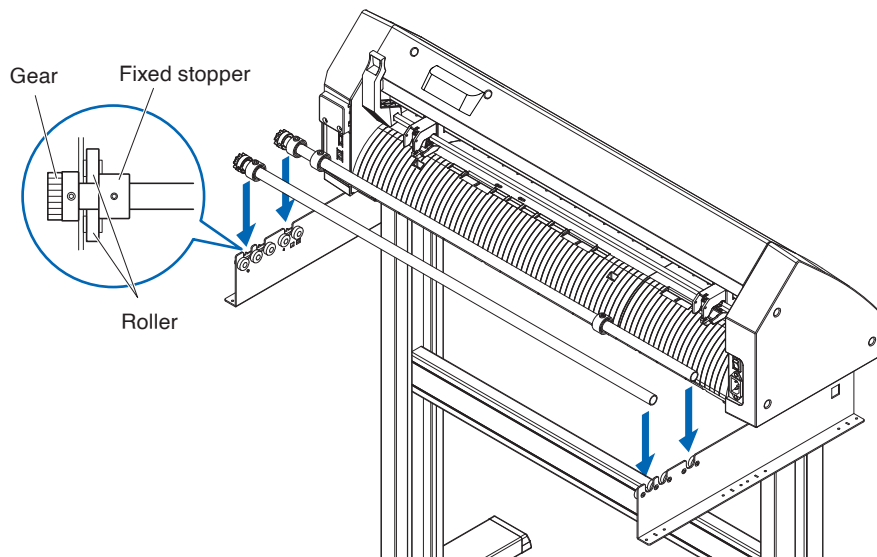

Mounting (CE8000-130)

1. Set one stopper in the stock shaft. (Keep the stopper screws slightly loose.)

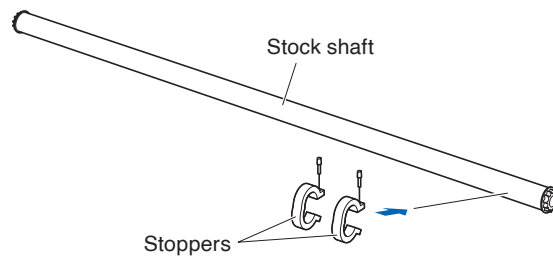

2. Slide the stock shaft into the media stocker.
Change the insertion position of the rear stock shaft according to the roll diameter of the media you want to use.

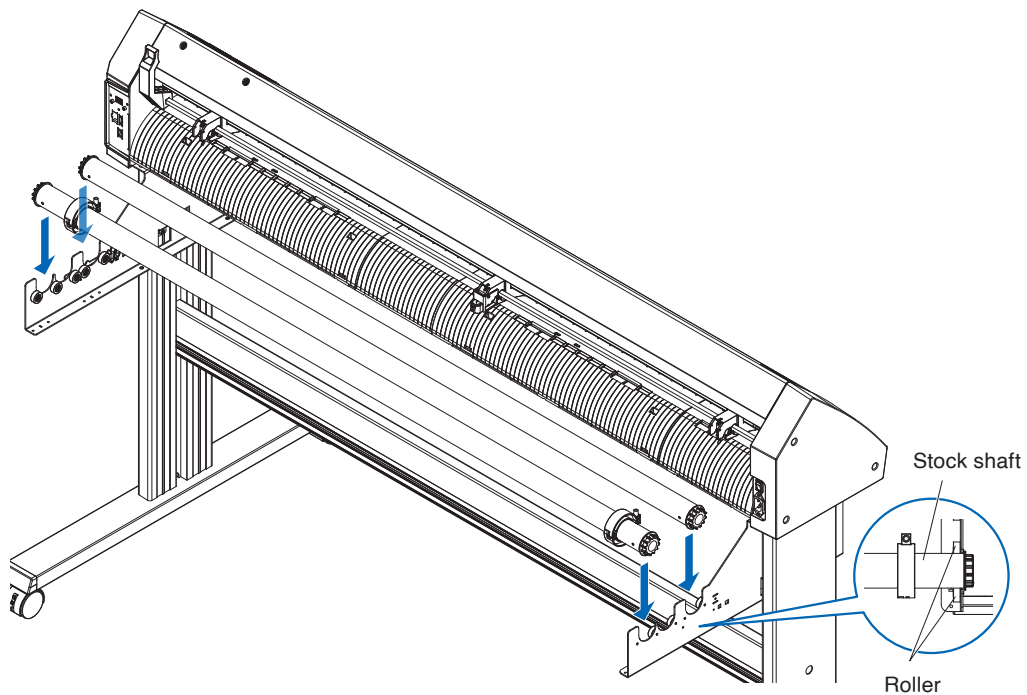

1.4 Connecting to the Computer

This section describes how to connect the plotter and the computer. Use either a USB port, wireless LAN or wired LAN* to connect the plotter to a computer. The driver software must be installed before connection.

* Wired LAN unit is factory-installed option.

When using USB/Wired LAN

Connection

1. Check that the power switch is turned off (the "O" side is pressed down).

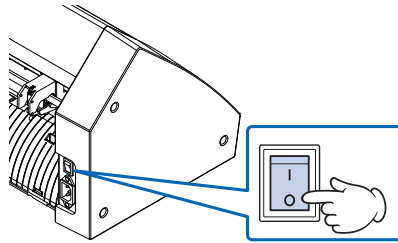

2. Connect the plotter to the computer using the interface cable.

* This section explains in the CE8000-130.

Supplement

See the "9.1 Setting Interface" for setting the interface.

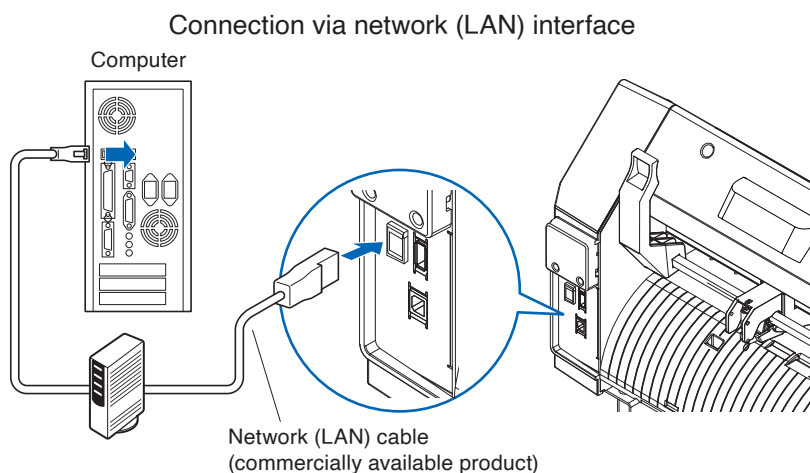
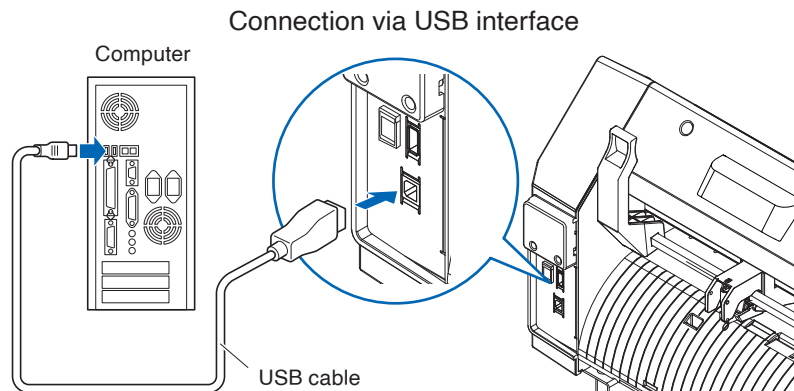

When using wireless LAN

Connection

1. Check that the power switch is turned off (the "O" side is pressed down).

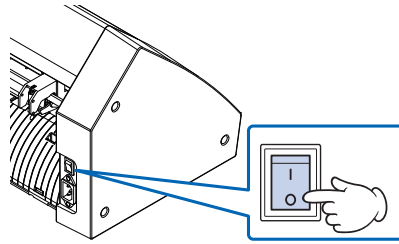

2. Remove the wireless LAN module cap.

* This section explains in the CE8000-130.

Wireless LAN module cap

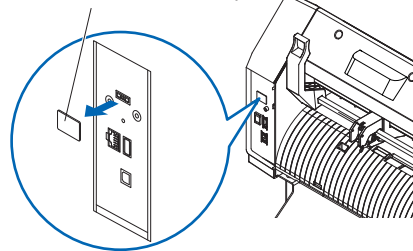

3. Install the wireless LAN module to the wireless LAN connection terminal.

Wireless LAN module

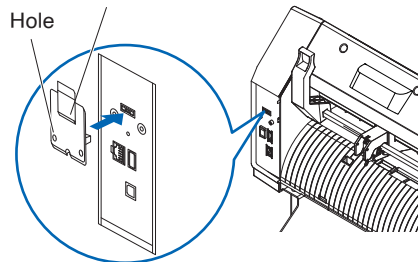

Supplement

Make sure that the wireless LAN module is firmly installed all the way.

4. Secure the wireless LAN module cover and the wireless LAN module with screws using a phillips screwdriver.

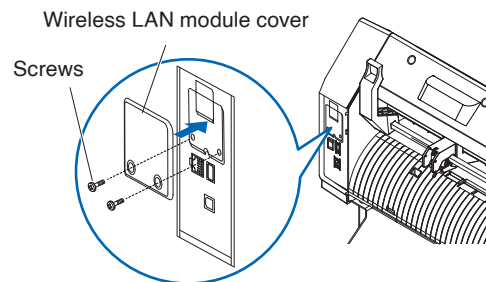

Supplement

- Please prepare your own phillips screwdriver.
- For wireless LAN settings, see "9.2 Connecting via wireless LAN"

Chapter 2: Preparing to Cut

This chapter describes how to prepare to start the cutting.

SECTION IN THIS CHAPTER

- 2.1 Preparation of Cutter Plunger*
- 2.2 Attaching a Tool*
- 2.3 Loading Media (Paper or Marking Film)*
- 2.4 Aligning the Push Rollers*
- 2.5 About the Default Screen*
- 2.6 Connecting to the Power*
- 2.7 How to Use Control Panel*
- 2.8 Setting Feeding Method*
- 2.9 Pre Feed of Media (Paper or Marking Film)*
- 2.10 Selecting Tool Condition*
- 2.11 Running Cutting Tests*
- 2.12 Displaying Cutting Area*

2.1 Preparation of Cutter Plunger

This section describes the structures and types of the cutter plungers (cutter pens).

Cutter plunger nomenclature

The plotter cuts using a cutter blade mounted in a plunger. There are two different plungers to suit the diameter of the cutter blade to be mounted (the 0.9 mm cutter plunger is provided as a standard accessory). Be sure to mount the cutter blade in the corresponding cutter plunger.

PHP33-CB09N-HS/PHP33-CB15N-HS

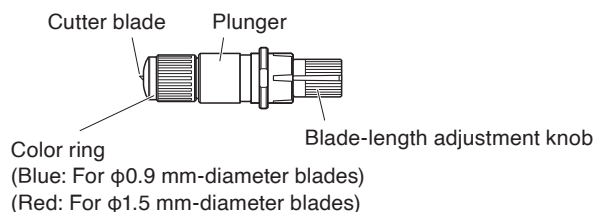

CAUTION

To avoid bodily injury, handle cutter blades with care.

Structure of cutter plunger

PHP33-CB09N-HS/PHP33-CB15N-HS

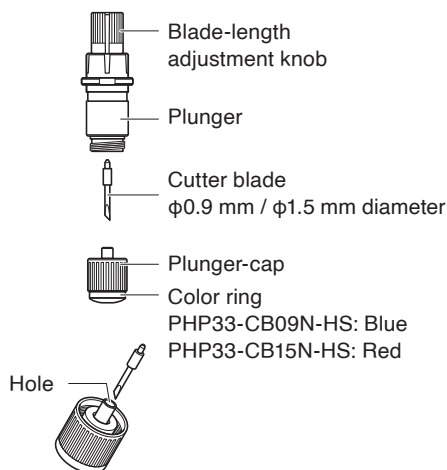

CAUTION

Please fully insert the cutter blade straight into the plunger cap.

If the cutter blade cannot be inserted straight, please insert the cutter blade after pressing the insertion port of the cutter blade several times. If not installed correctly, it may result in damage to the cutter blade or the plotter itself.

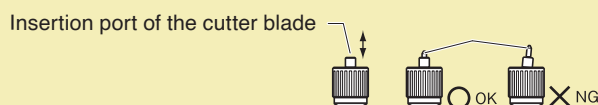

Adjusting the blade length

Blade length needs to be adjusted to perform optimal cut.
Perform few test cuts and set the optimal blade length.

CAUTION

- To avoid bodily injury, handle cutter blades with care.
- It may result in damaging the cutter blade or the cutting mat if the blade is extended too much. Make sure the blade length is set less than the thickness of the media.
After adjustment, please always perform "CUT TEST".

Supplement

See "2.11 Running Cutting Tests" for cutting tests.

Adjust the blade length by turning the blade-length adjustment knob. Turn the knob in direction "A" to extend the blade, or in direction "B" to retract the blade. When the knob is turned by one scale unit, the blade moves approximately 0.1 mm. One full turn of the knob moves the blade approximately 0.5 mm.

PHP33-CB09N-HS/PHP33-CB15N-HS

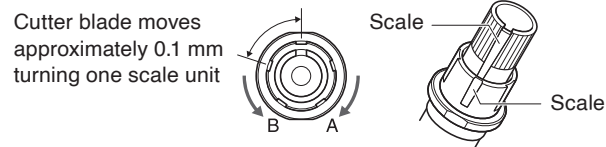

Blade application and features

Select the optimal cutter blade and media to be cut.
Refer to the Cutter Blade Manual.

CAUTION

To avoid bodily injury, handle cutter blades with care.

2.2 Attaching a Tool

Attach a tool (cutter plunger, plotter pen) to the plotter.

Attaching a tool

When mounting the tool in the tool holder, please note the following.

⚠ CAUTION

- Never touch the tool when the power is turned on or while it is in operation, as it is dangerous.
- When handling the tool holder, be careful not to get injured by the cutter blade.

It is explained here using cutter plunger as an example.

Supplement

- When using with half cutting and plotter pen, set the seal in Tool Holder (backward), and when using cutting out (perforated cut), set the seal in Tool Holder (forward).
- Half cutting means that only the marking film is cut out, leaving the backing sheet uncut.
- Cutting out means that the media is cut out completely.
- Structure of Marking film

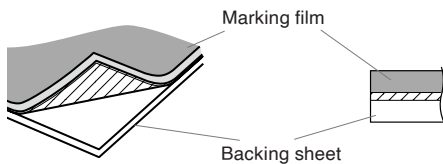

Mounting

1. Loosen the tool holder screw.

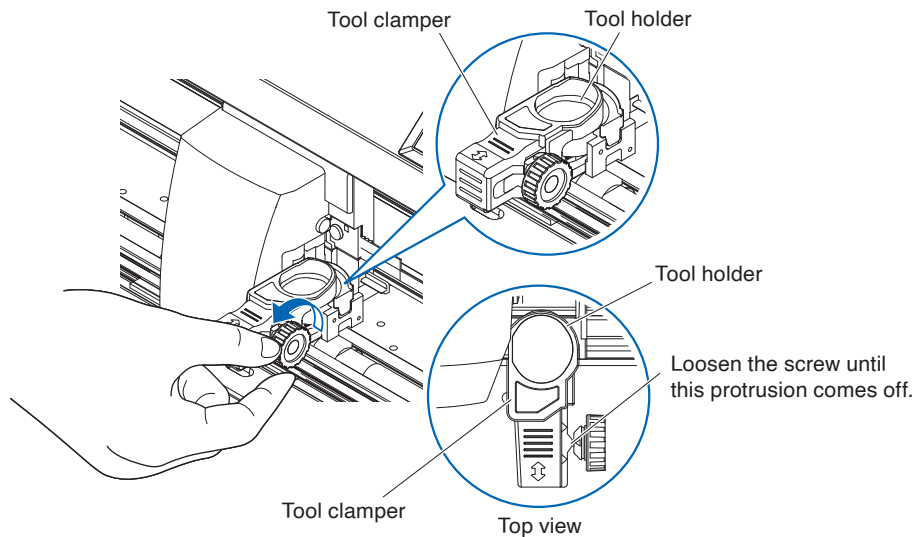

2. Move the tool clamber so that the hole in the tool clamber is aligned with the hole in the tool holder.

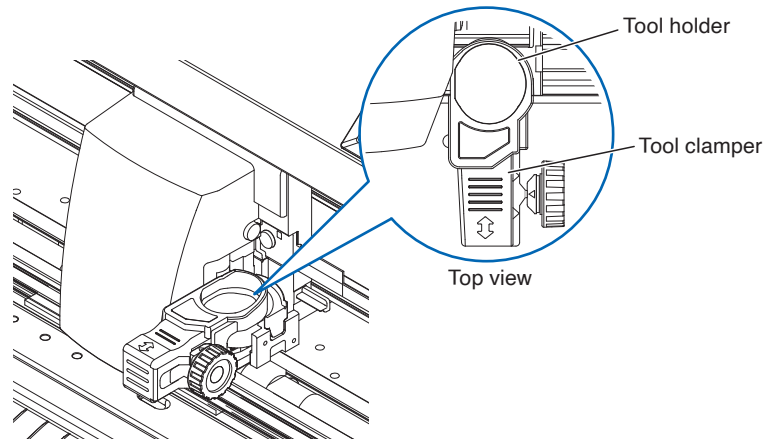

3. While pushing up the tool clamber, set the tool in the tool holder.

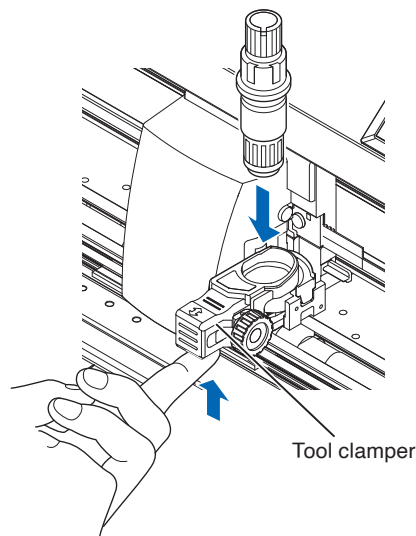

Supplement

Make sure the tool is set straight into the tool holder.

4. Move the tool clamber.
 When using with half cut and pen, push the tool clamber until it touches the backward side firmly.
 When using the cutting out (perforated cut), pull the tool clamber until it touches the forward side firmly.

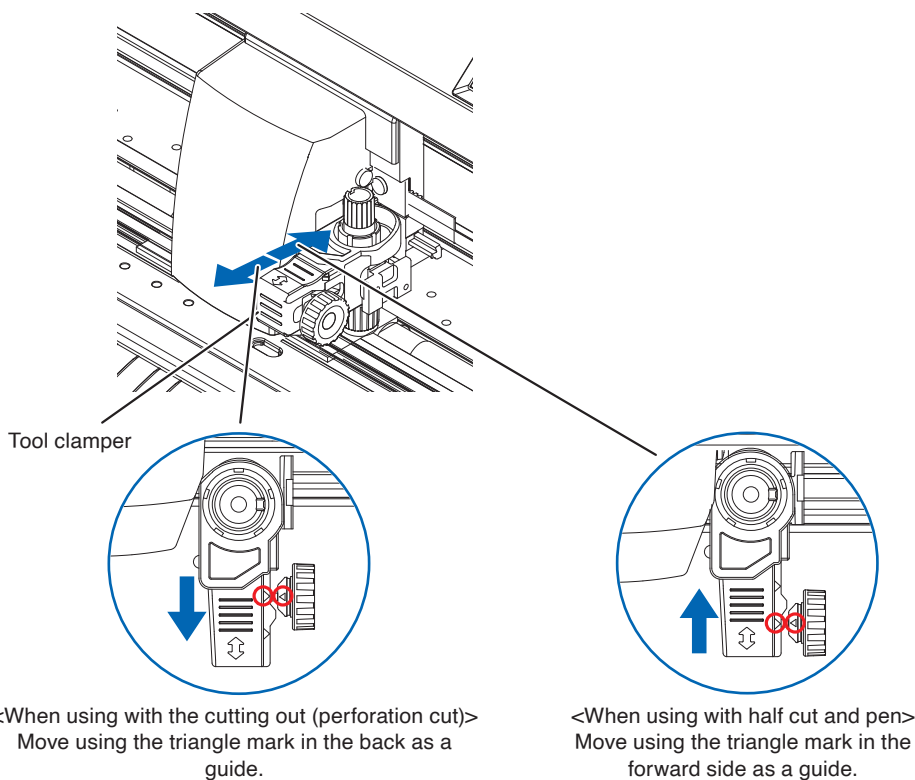

Supplement

Make sure the tool is set straight into the tool holder.

5. Tighten the tool holder screw.

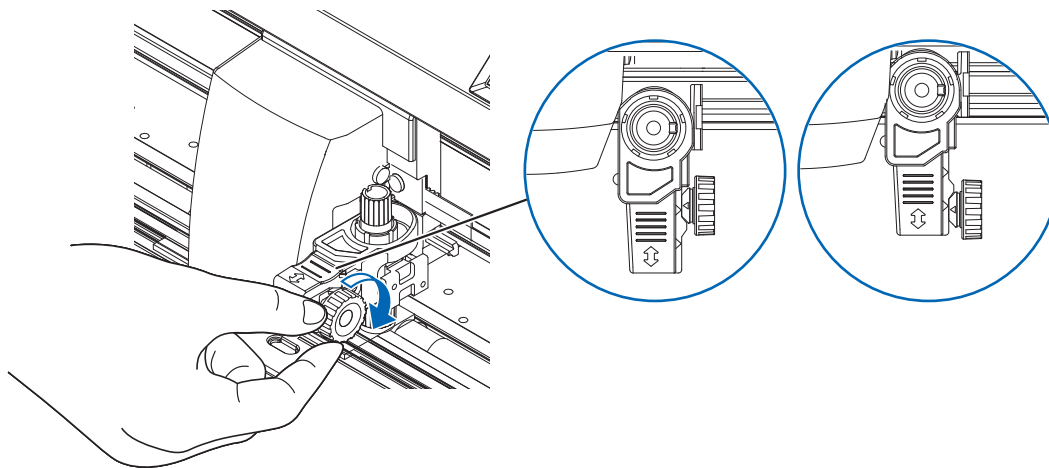

Removing the tool

To remove the tool, loosen the screw until this protrusion mentioned in step 1 of "Attaching a tool" comes off and then remove the tool.

2.3 Loading Media (Paper or Marking Film)

Both roll media and sheet media can be used with the CE8000. Load the media according to the instructions given for each type.

Use the grit roller on the right side of the media (looking from the front) as a guide when setting it in the media sensor. Afterwards, adjust the push roller so that it's lined up with the side of the media.

- Loading Roll Media
- Loading Sheet Media

Loading roll media (CE8000-40)

Operation

1. Lower the media set lever to raise the push rollers.

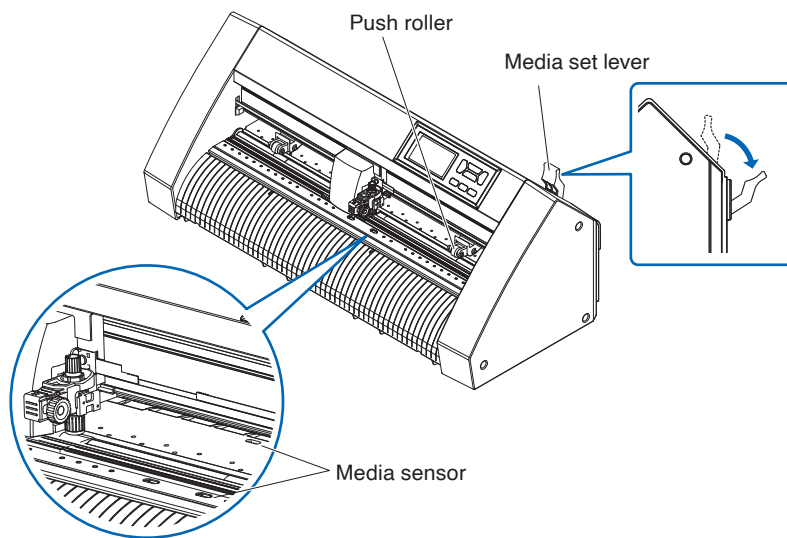

2. Put the roll media on the roll media tray and then push the tip of the roll media forward from the back of the machine. Make sure to pull it so that there is no slackening across the roll media's route.

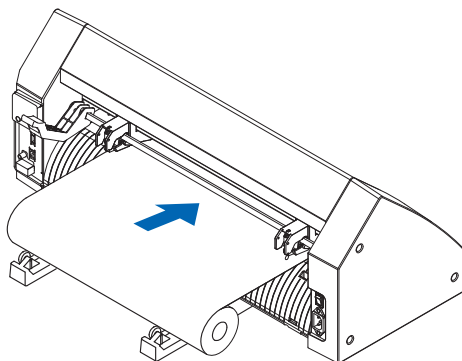

3. Pull the roll media forward until the leading edge of the roll media completely covers the sensor. If the length you pull out is too long, adjust the length by winding it up on the roll side.

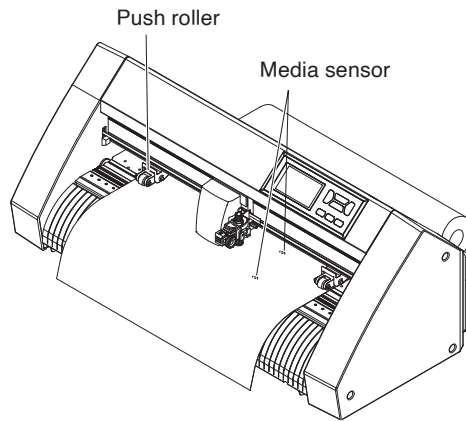

4. Position the media and the push rollers to correspond with the width of the media. The push rollers push down on either side of the media. Use the grit roller position guide to make sure the push rollers are set on top of the grit rollers. You can adjust the center push roller's hold-down force.

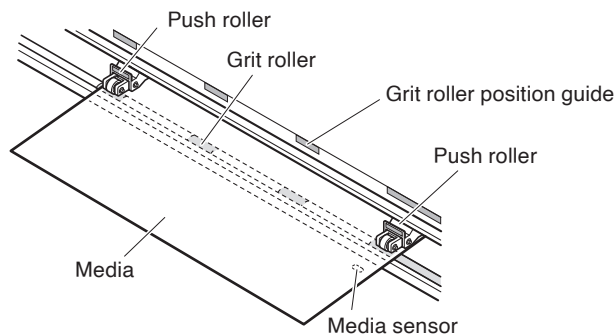

Supplement

- The media must always be positioned over the media sensor.
- See "2.4 Aligning the Push Rollers" for the position of the push rollers.

When feeding long media (2 meters or more)

Position the push rollers at least 15 mm inside the edges of the media.

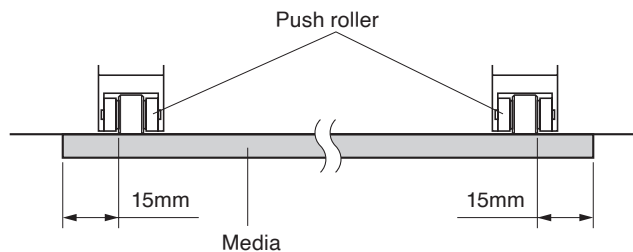

When feeding long media (2 meters or less)

Position the push rollers at least 5 mm inside the edges of the media.

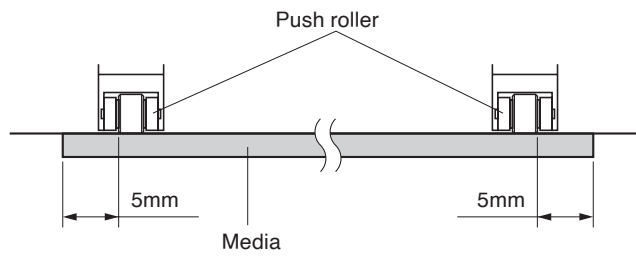

5. Pull the media taut to make sure that there is no slack in the conveyance path, and then raise the media set lever to lower the push rollers.

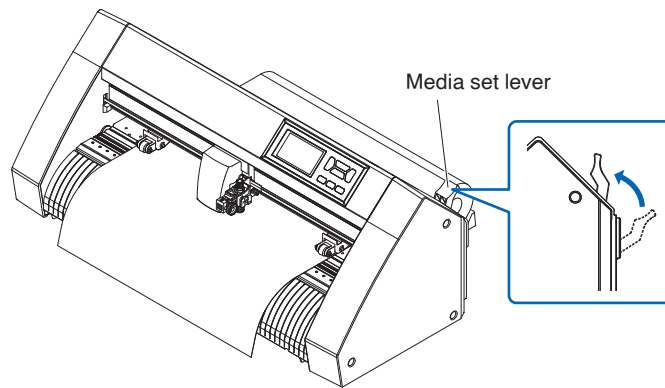

Create the same amount of slack in the media as will be used for the back of the machine.

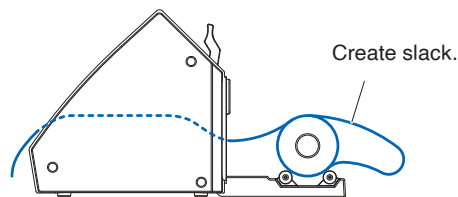

Loading roll media (CE8000-60/130)

This section explains in the CE8000-130.

Operation

1. Lower the media set lever to raise the push rollers.

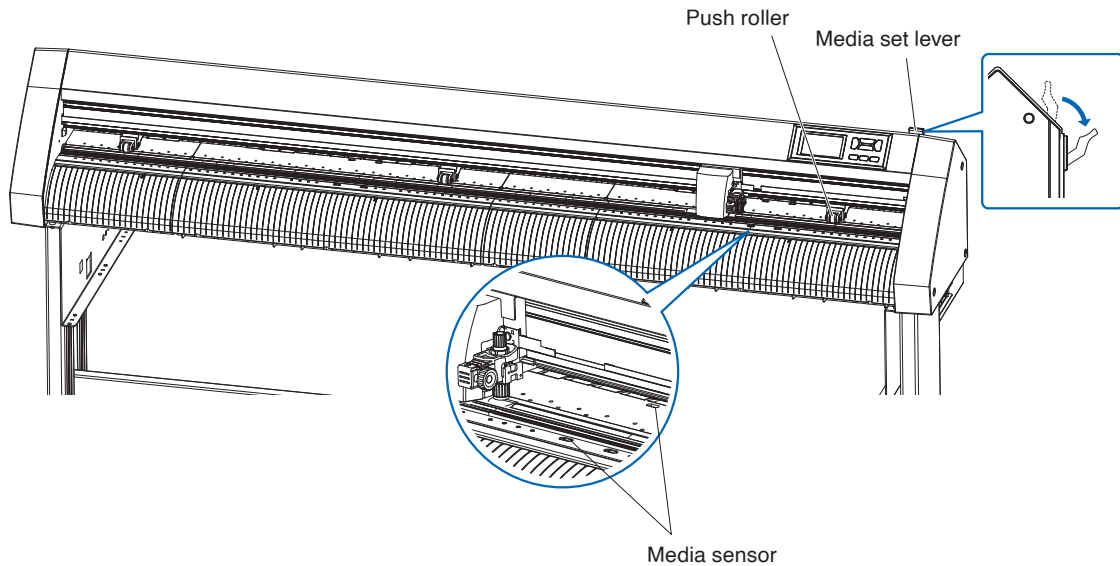

2. Set the roll media on top of the stock shaft, and then clip the roll paper with a stopper. Once it's set, tighten the stopper's screws.

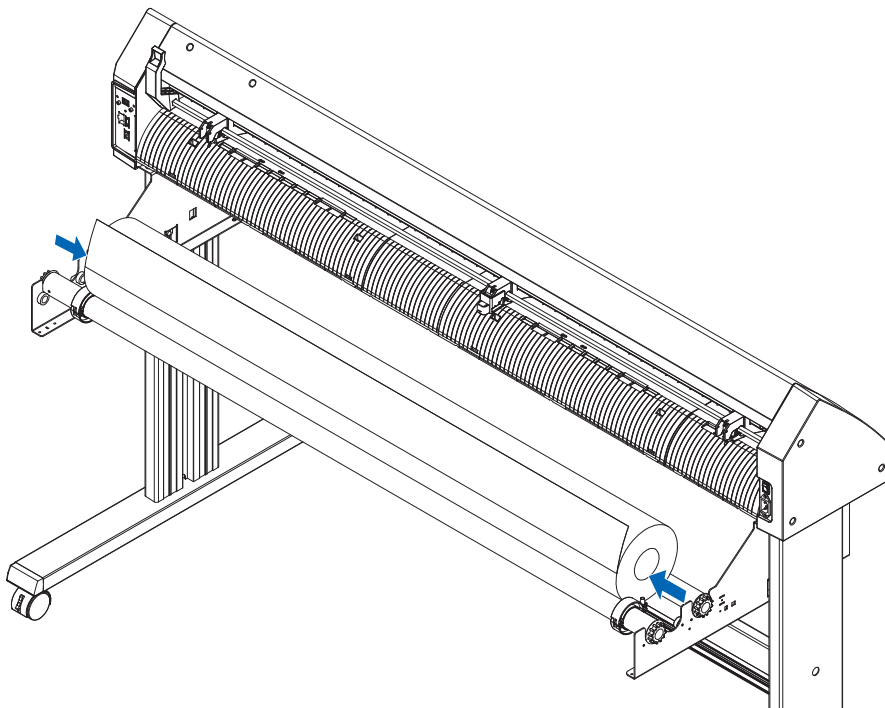

3. Push the tip of the roll media forward from the back of the CE8000. Make sure to pull it so that there is no slackening across the roll media's route.

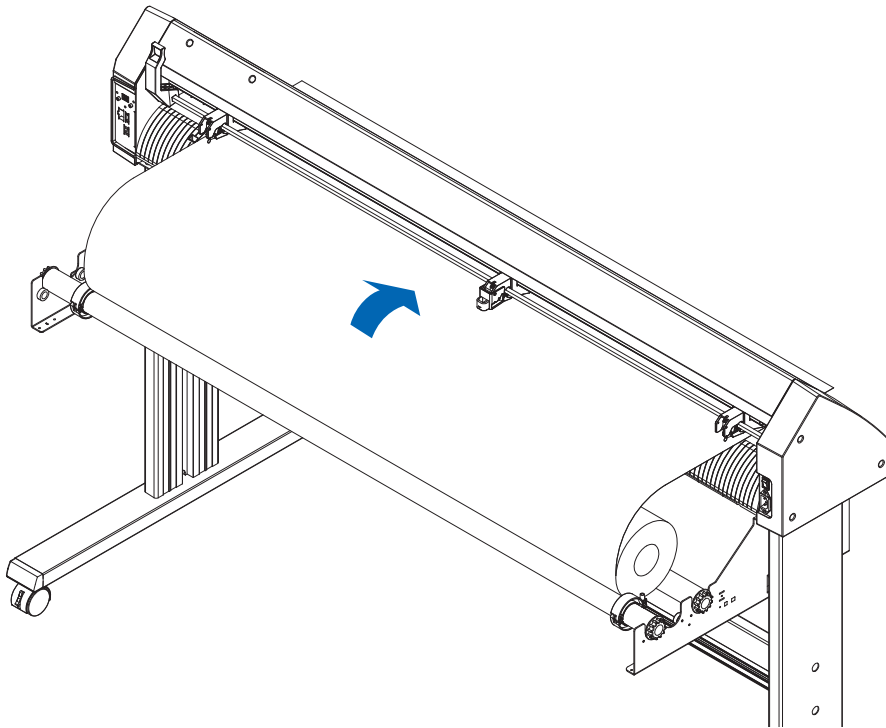

4. Lock the media stopper (Slide it backward.) and pull it out evenly so that the roll paper is straight. Please load so that the roll paper always rests on the media sensor.

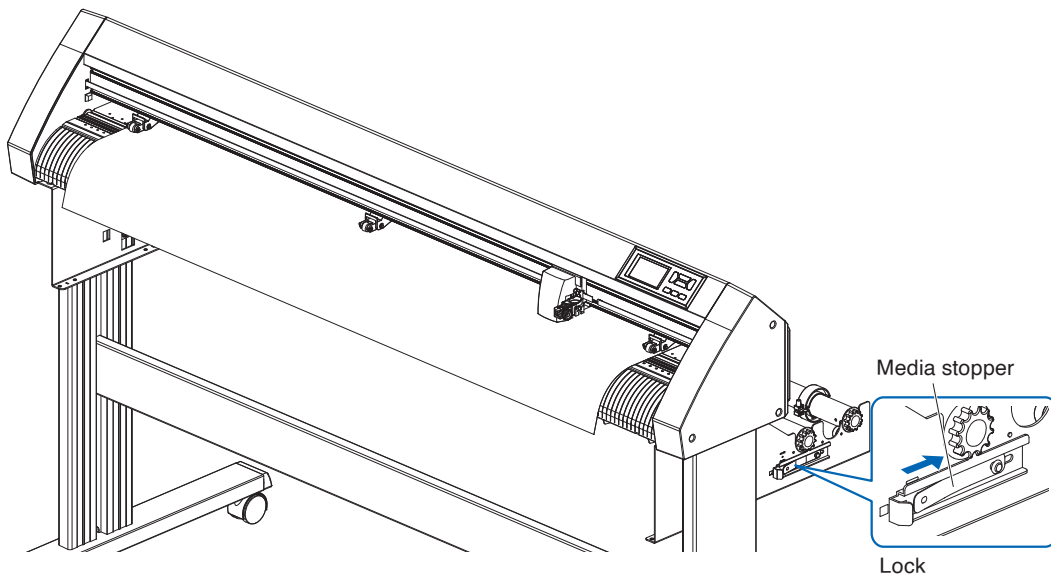

Supplement

When actually cutting, please release the lock from the media stopper (While pulling the media stopper to the exterior, slide it forward.).

5. Position the media and the push rollers to correspond with the width of the media.

When using CE8000-40/60

The push rollers push down on either side of the media. Use the grit roller position guide to make sure the push rollers are set on top of the grit rollers.

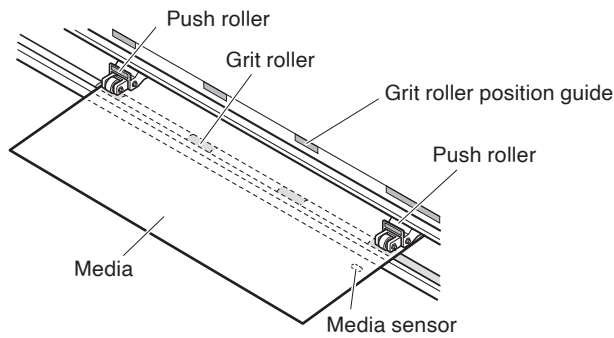

Supplement

- The media must always be positioned over the media sensor.
- See "2.4 Aligning the Push Rollers" for the position of the push rollers.

When using CE8000-130

Use the 3 push rollers to push down the sides and center of the media. Use the grit roller position guide and make sure the push rollers are on top of the grit rollers.

The central push roller has the push roller's hold-down force switching function.

Supplement

- The media must always be positioned over the media sensor.
- See "2.4 Aligning the Push Rollers" for the position of the push rollers and information about push roller hold-down force.

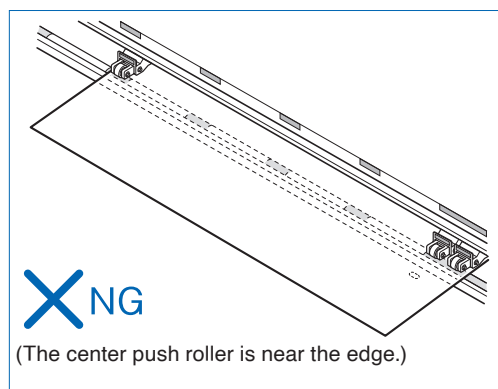
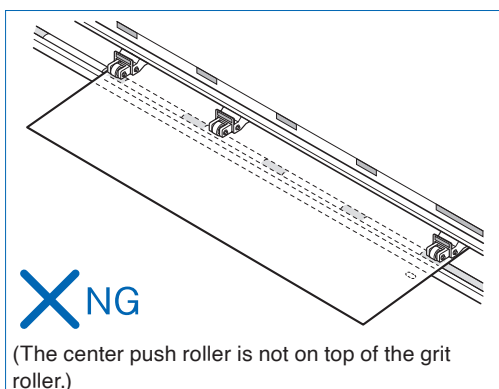
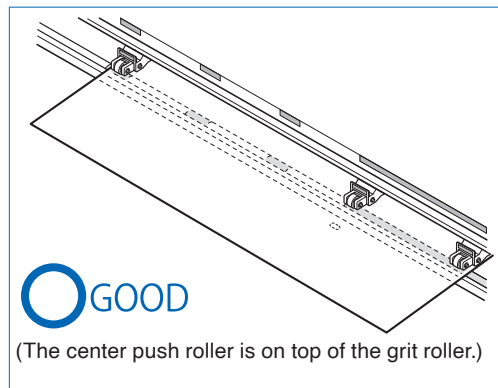
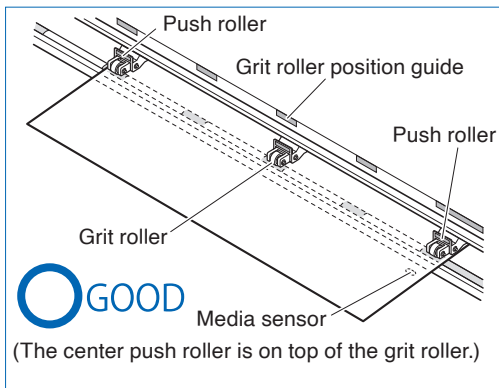

When feeding long media (2 meters or more)

Position the push rollers at least 15 mm inside the edges of the media.

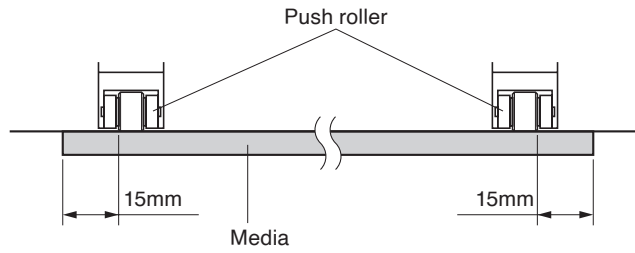

When feeding long media (2 meters or less)

Position the push rollers at least 5 mm inside the edges of the media.

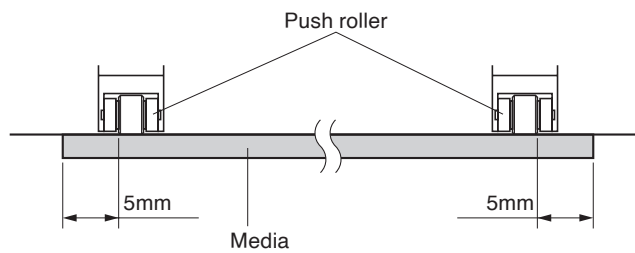

6. Pull the media taut to make sure that there is no slack in the conveyance path, and then raise the media set lever to lower the push rollers.

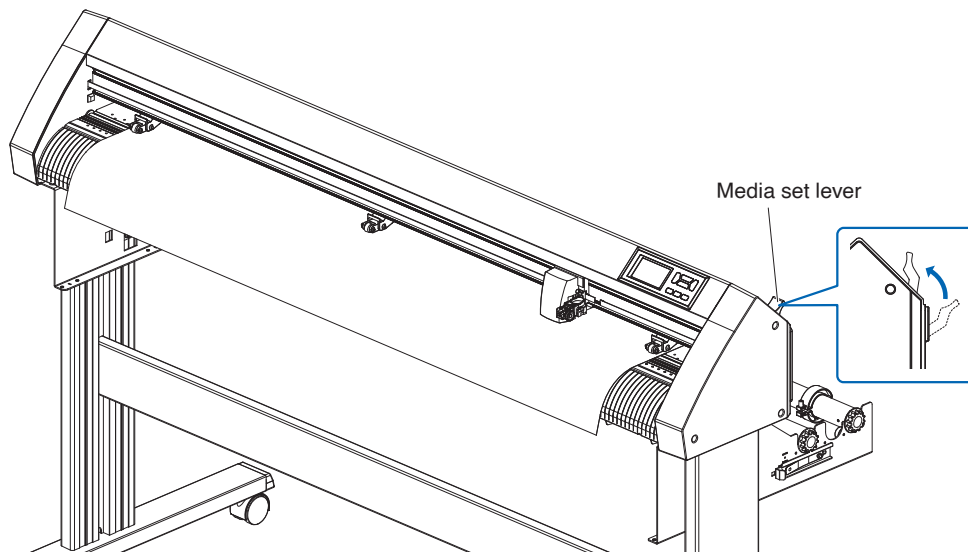

7. Release the lock from the media stopper (while pulling to the exterior, slide it forward).

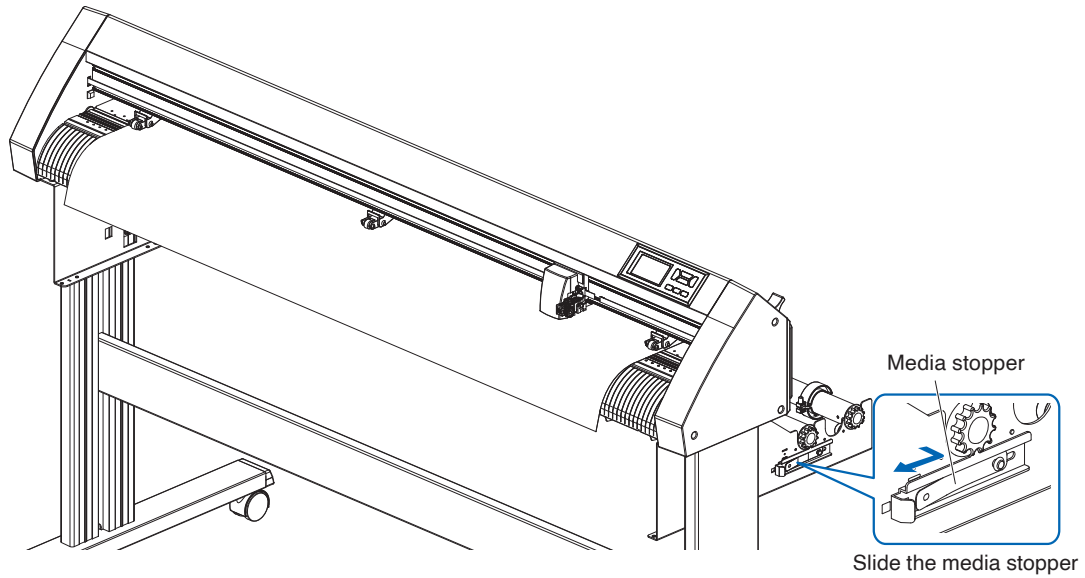

8. When the set lever is up (and the media is held down by the push rollers) and the media stopper is unlocked, pull out the roll media and give it slack. Create the same amount of slack in the media as will be used for the back of the machine.

Supplement

- Dirt from the floor may stick to the media when giving it slack, so please be careful.
- During continuous operation with roll media, do not make a media slack at the rear of the cutting plotter.

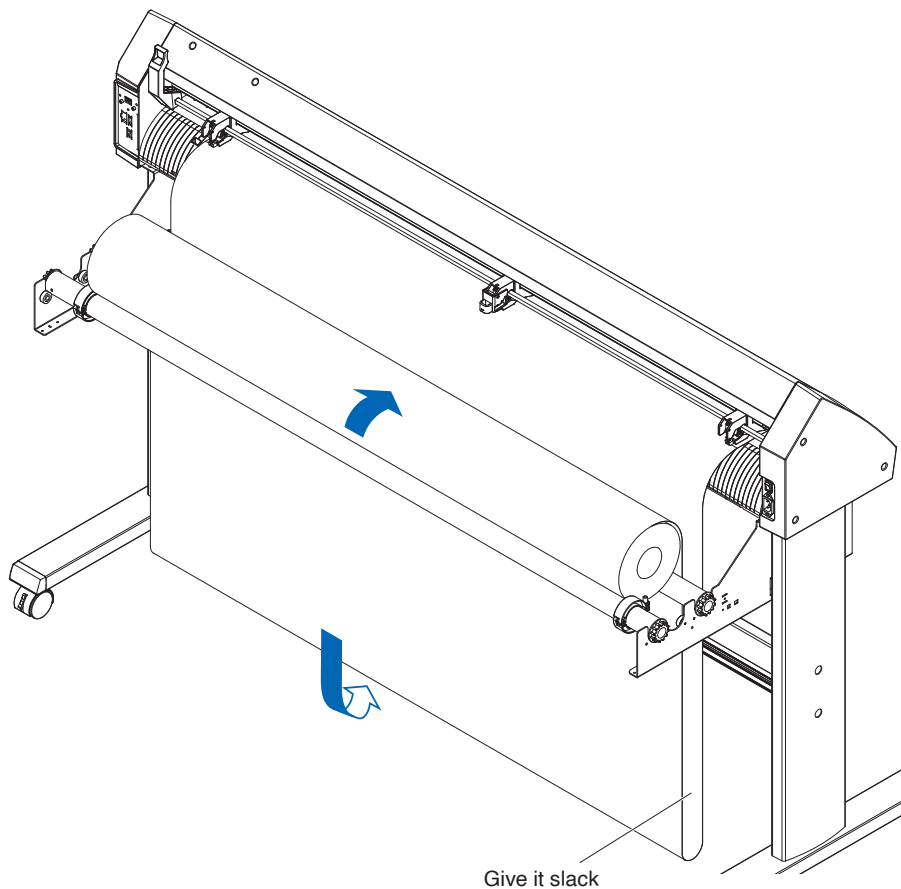

Loading sheet media (CE8000-40/60)

This will be explained in CE8000-60.

Operation

1. Lower the media set lever to raise the push rollers.

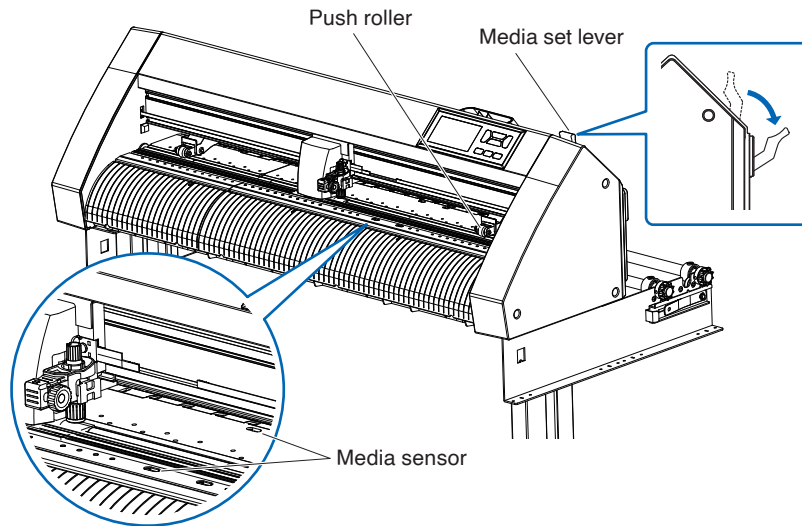

2. Load the sheet media so that the sheet media's right edge lines up with the guideline on the front side. Make sure that the sheet media completely covers the media sensor.

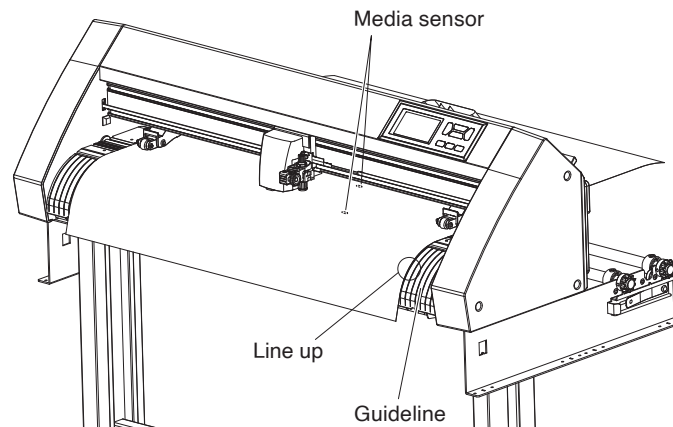

3. Position the media and the push rollers to correspond with the width of the media. The push rollers push down on either side of the media. Use the grit roller position guide to make sure the push rollers are set on top of the grit rollers. You can adjust the center push roller's hold-down force.

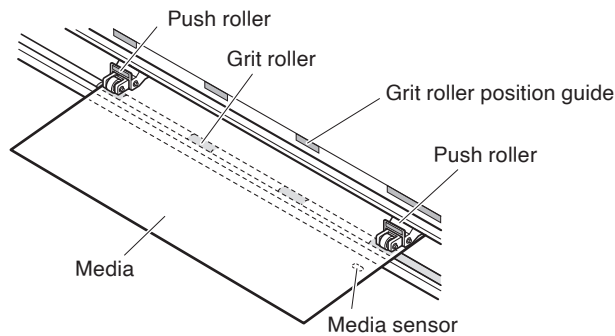

Supplement

- The media must be at least 125 mm in length.
- The media must always be positioned over the media sensor. (For the location of media sensor, see "1.2 Nomenclature".)
- See "2.4 Aligning the Push Rollers" for information about the position of the push rollers.

4. Load the sheet media so that the sheet media's right edge lines up with the guideline on the front side. Pull the media taut to make sure that there is no slack in the conveyance path, and then raise the media set lever to lower the push rollers. Set the sheet media so that the paper's edges line up with the guideline on the front side.

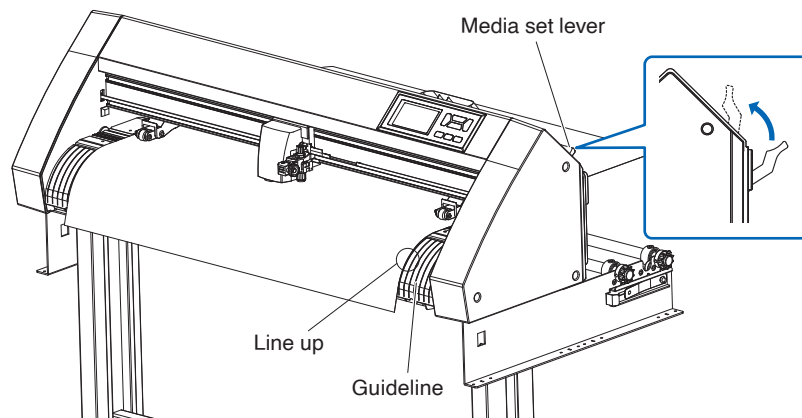

Loading sheet media (CE8000-130)

Operation

1. Lower the media set lever to raise the push rollers.

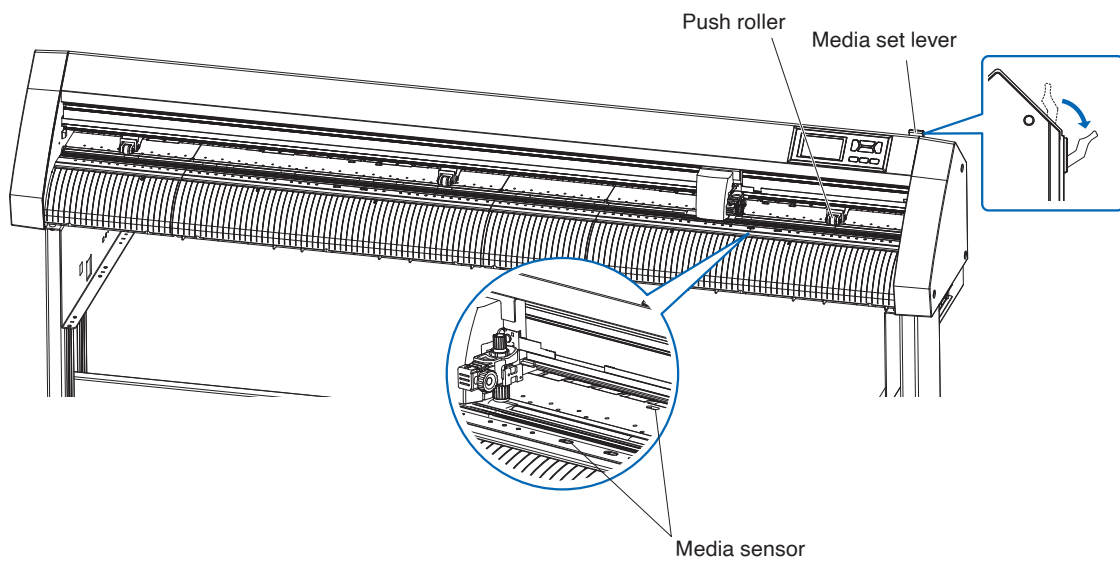

2. Load the sheet media so that the sheet media's right edge lines up with the guideline on the front side. Make sure that the sheet media completely covers the media sensor.

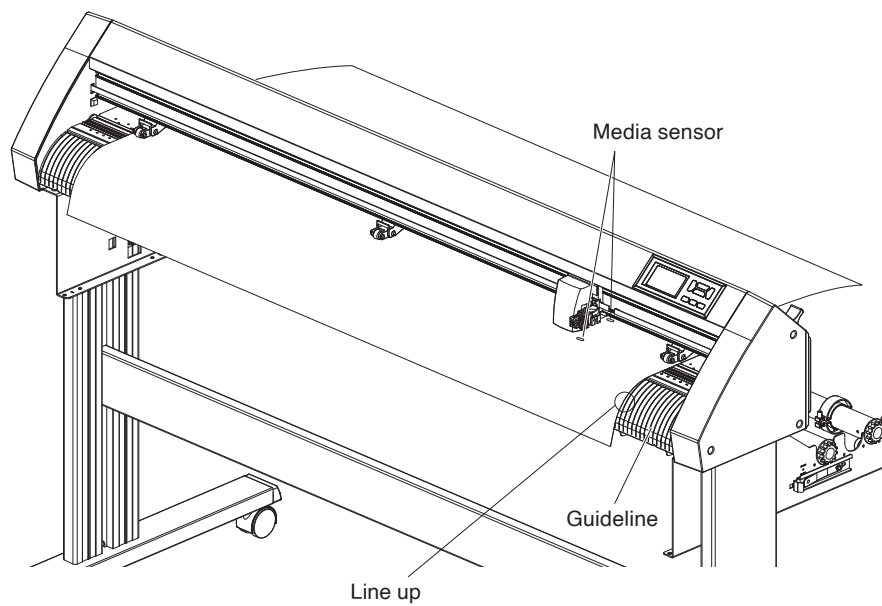

3. Position the media and the push rollers to correspond with the width of the media. Use the 3 push rollers to push down the sides and center of the media. Use the grit roller position guide and make sure the push rollers are on top of the grit rollers.

Supplement

- The media must always be positioned over the media sensor.
- See "2.4 Aligning the Push Rollers" for the position of the push rollers and information about push roller hold-down force.

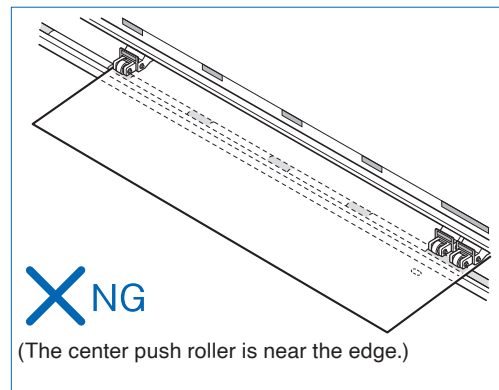
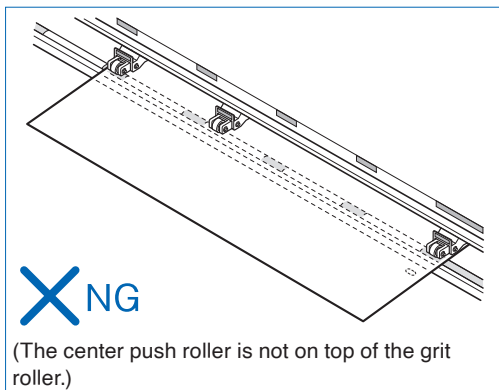
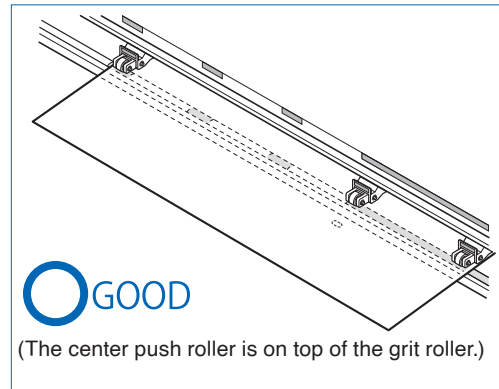
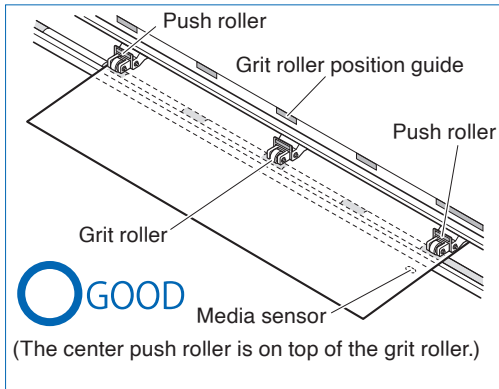

4. Load the sheet media so that the sheet media's right edge lines up with the guideline on the front side. Pull the roll media taut to make sure that there is no slack in the conveyance path, and then raise the set lever to fix the push roller position and the roll paper.

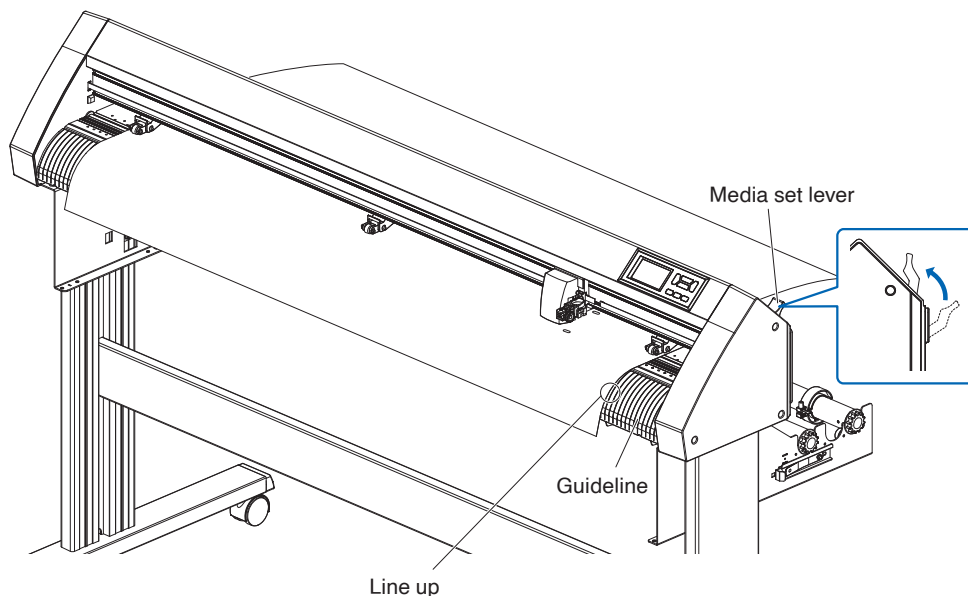

Carrier Sheet (for Affixing Media for Cutting)

Using the carrier sheet (CR09300-A3) enables designs to be cut out of the following media types:

- Media without a backing sheet
- Media that is smaller than A3 size
- Only CE8000-40/60 supports it.
- The carrier sheet (CR09300-A3) is an optional item.

Usage Precautions

- Be sure to use the carrier sheet when cutting around a printed design on the media to create a cutout.
- The carrier sheet is a reusable adhesive sheet that can be used repeatedly. However, if the carrier sheet become warped or loses its adhesive strength, it can no longer be used. In such cases, please replace it with a new carrier sheet. As a guideline, replace the carrier sheet after cutting 10 sheets. The cutting quality when the same carrier sheet is used for cutting more than 10 sheets is not guaranteed.
- When affixing a media to the carrier sheet, be sure to press down on it firmly to ensure that it does not float up or peel away from the carrier sheet.
- Make sure that media affixed to the carrier sheet has very little curl. A strongly-curved media may cause registration mark reading errors to occur, and it may get caught up in the pen carriage.
- Affix only Graphtec-specified media to the carrier sheet. If using commercially-available inkjet media, please note that media that is coated on both sides cannot be used. If the media is coated on one side only, affix the non-coated side to the carrier sheet. If the coated side is affixed, the carrier sheet's adhesive strength will be weakened and may make the carrier sheet unusable.
- If very smooth paper (paper that does not feel rough to the touch) is affixed to the carrier sheet, it will tend to curl up when removed from the carrier sheet. Please be careful when using it.
- When removing a media from the carrier sheet after cutting it, be sure to remove it slowly and carefully.
- The adhesive surface of the carrier sheet absorbs moisture easily. To prevent this occurring, do not remove the carrier sheet from its package until just before use.
- After use, reattach the separator that was removed from the adhesive surface prior to use, and then return the carrier sheet to its package for storage.
- For optimum storage, avoid locations where there is high humidity or where the package will be exposed to direct sunlight.
- There may be cases in which thin materials such as copy paper can no longer be peeled or torn.

Loading the Media

How to load a media with a width of less than 297mm

1. Peel off the separator (yellow) from the carrier sheet to expose the adhesive surface. (Do not discard the separator, as it will be used again when the carrier sheet is returned to its package for storage.)

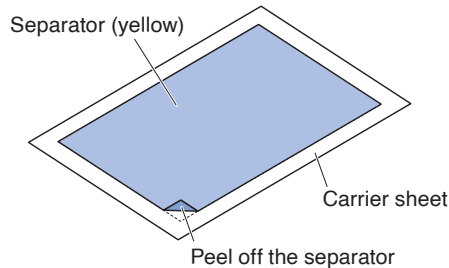

2. Affix the media for cutting to the adhesive surface of the carrier sheet, making sure that the edges of the media are parallel with those of the carrier sheet.

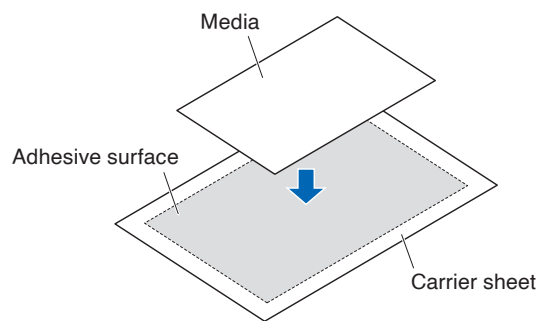

Supplement

- Do not use media that is smaller than postcard size.
- When affixing the media, take care not to cause any air bubbles or creases.

Effective Cutting Area

1. The effective cutting area on the carrier sheet is shown in the diagram below. When loading a media that is smaller than A3 size in the cutting plotter, be sure to affix it within the cutting area (the adhesive surface). Moreover, make sure that the edges of the media are parallel with the edges of the carrier sheet.

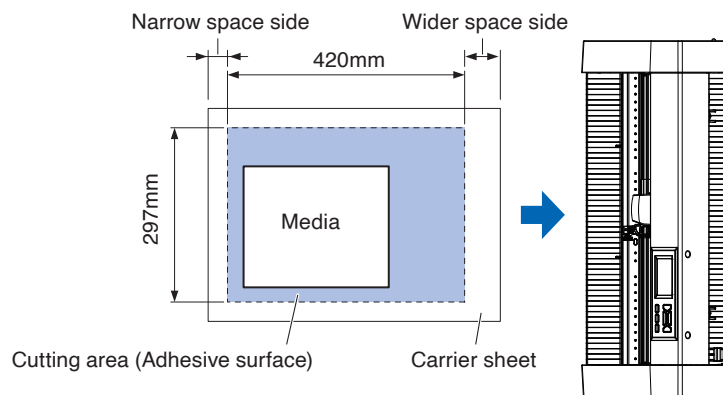

Supplement

- The plotter recognizes the width of the carrier sheet as the cutting area. Be sure to load a media that is the same size as the media setting that was made in the application software
- Be sure to use the [ORIGIN] in "QUICK MENU" menu to specify the start position of the cutting operation.

Mounting the Carrier Sheet Table

1. Mount the carrier sheet table to the front and back of the cutting plotter.
Insert the projection under the carrier sheet table into the dent part.
For CE8000-40, insert the front side into the first and third grooves from the right. Align the back side in the same position as the front side.
For CE8000-60, insert the front side into the second and fourth grooves from the right. Align the back side in the same position as the front side.
* The carrier sheet table (OPH-A45) is an optional item.

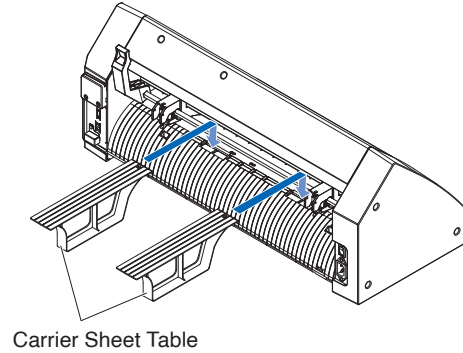
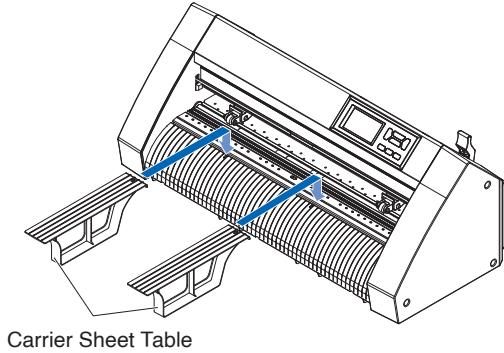

Setting method of carrier sheet (Carrier Sheet Table)

1. When setting the carrier sheet, insert it so that the narrowest margin (transparent part) of the carrier sheet is at the top, and make sure that the carrier sheet is in front of the cutting plotter as shown in the figure. Make sure that the carrier sheet does not come out behind the cutting plotter.

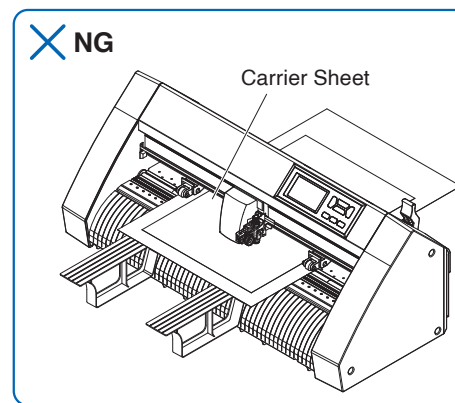
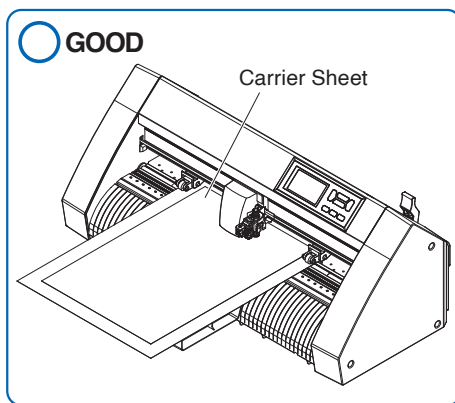

Set it so that the right edge of the carrier sheet aligns with the guidelines on the front guide.

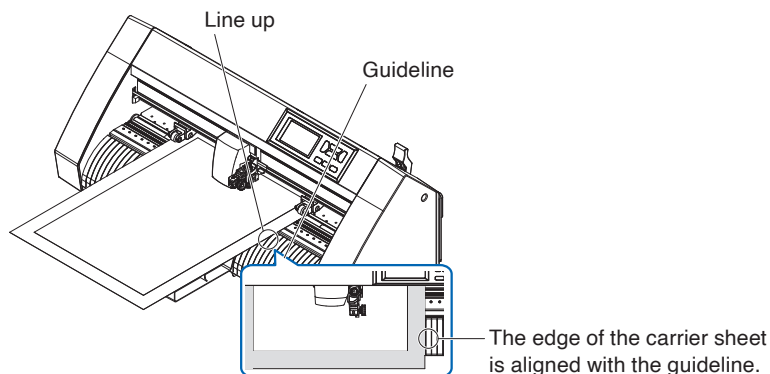

2. When the set lever is raised, the push roller lowers and the carrier sheet is fixed.

2.4 *Aligning the Push Rollers*

This section describes how to alignment of the push rollers.

Aligning the push roller

Position the left and right push rollers to correspond with the width of the media. Adjust the push rollers so that they are positioned above both the media and the grit rollers.

Positioning the push rollers within the grit roller position guides ensures that they are above the grit rollers.

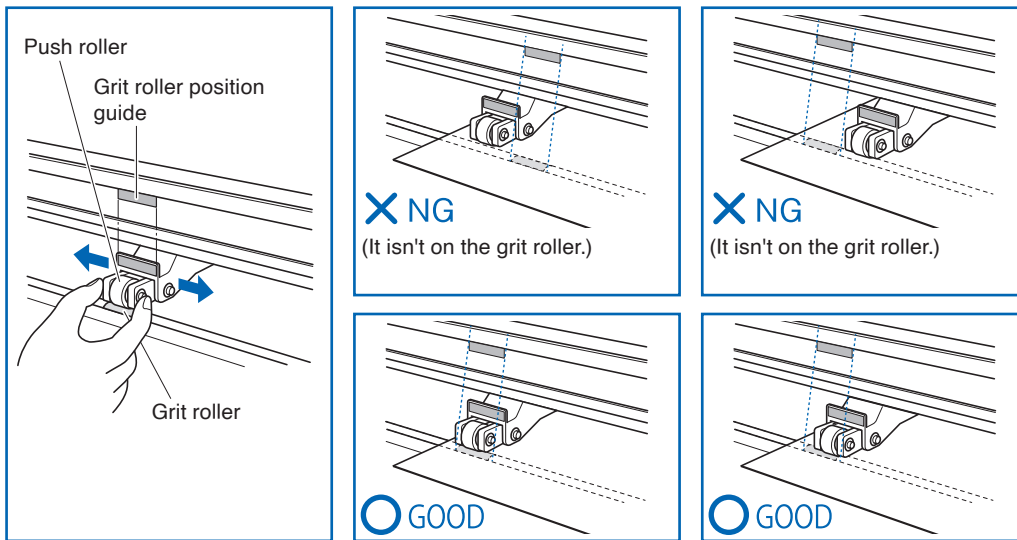

CAUTION

To move the push rollers, the media set lever must be in the lowered position.

Supplement

If a [REALIGN PUSH ROLLERS] message appears after setting the media and raising the media set lever, it means the right push roller is not on the right grit roller, or that the left or center push roller is not on the proper grit roller. Make sure everything is set correctly.

When feeding long media (2 meters or more)

Position the push rollers at least 15 mm inside the edges of the media.

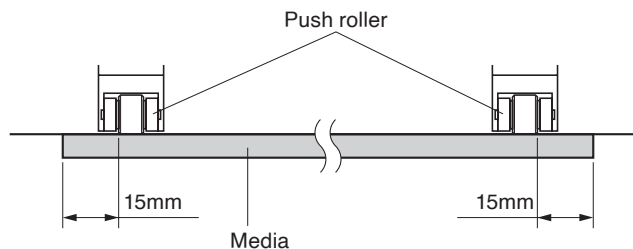

When feeding long media (2 meters or less)

Position the push rollers at least 5 mm inside the edges of the media.

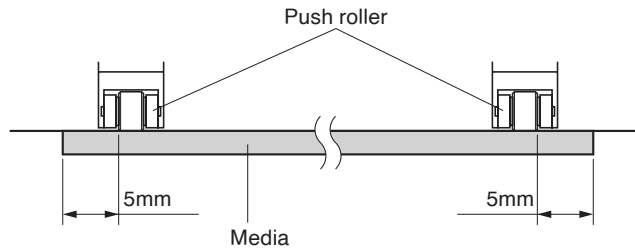

When narrow media is used

Make sure that all push rollers are on the long right grit roller. Use the left side of the grit roller as a starting point and then set the push rollers so that they're on both sides of the media.

The width of media that can be set is 50 mm or more for CE8000-40/60 and 85 mm or more for CE8000-130.

* For CE8000-130, when setting all push rollers to the rightmost grit roller (wide), set the hold-down force of the center push roller to Low (OFF).

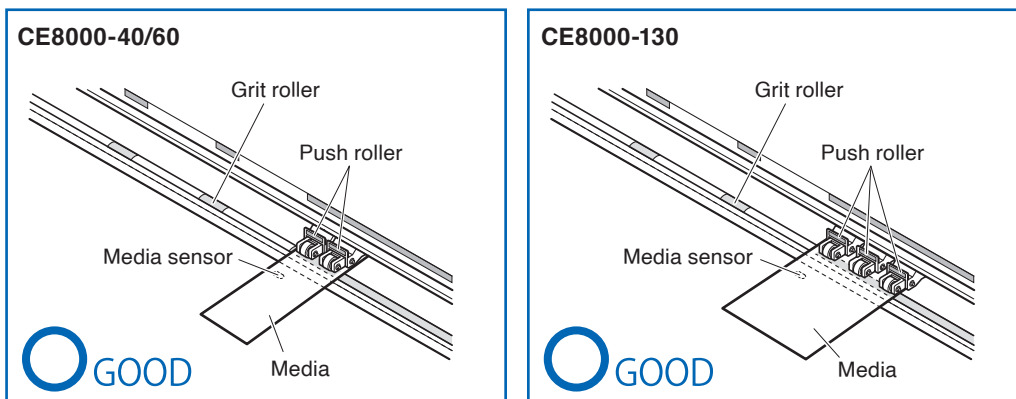

⚠ CAUTION

- The media must be at least 125 mm in length in media feed direction.
- The media must always be positioned over the media sensor.

Changing the hold-down force

The CE8000-130 requires the push roller hold-down force to be set based on the media's width and material type in order to keep the media in place.

Switching

1. Lower the media set lever and raise the push roller.
2. Switch the hold-down force of the central push roller to Medium or Low (OFF) using the hold-down force switching lever at the rear of the push roller.
3. Raise the hold-down force switching lever to set it to the Medium state, and lower it to set it to Low (OFF).

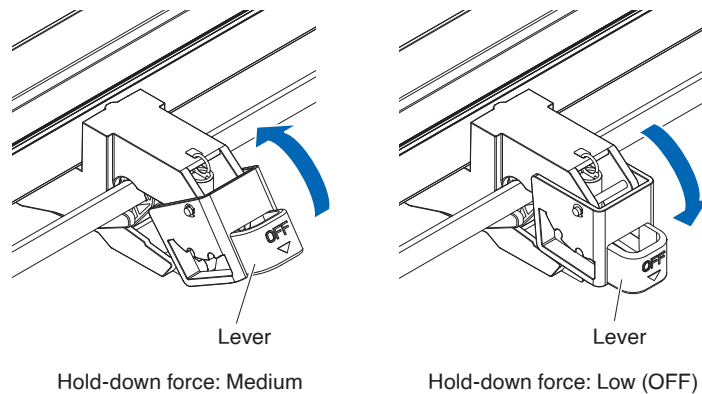

CAUTION

- The hold-down force of the push rollers at both ends cannot be changed.
- When switching the hold-down force, be sure to lower the set lever before switching.

Supplement

- Set the hold-down force to be Low (OFF) when cutting by pressing the center of ultra-thin film such as car film.
- Please change the hold-down force depending on the type of media.
- When using the push roller with the hold-down force set to Low (OFF), set "Enabling/Disabling the push roller sensors (Enabling/Disabling the push roller sensors)" to [INSIDE DISABLED]. And then move the push roller to a position where there is no grit roller.

2.5 About the Default Screen

The Initial Setup Screen appears only when powering up the machine for the first time after purchase. Here, you can set the "Display language", "LENGTH UNIT" and "Wireless LAN".

Also, after setup, you can select the menu even from the READY status.

See "2.6 Connecting to the Power" for turning on the power.

Operation

1. Once the machine is powered on (with the " | " switch) a message will be displayed after the firmware version is displayed.

PLEASE SELECT LANGUAGE		
English	日本語	Deutsch
Francais	Italiano	Espanol
Portugues	РУССКИЙ	中文
한글		

2. Press the language you want to use.

PLEASE SELECT LANGUAGE		
English	日本語	Deutsch
Francais	Italiano	Espanol
Portugues	РУССКИЙ	中文
한글		

3. Press the unit you want to use.

LENGTH UNIT	
PLEASE SELECT LENGTH UNIT	
METRIC	INCH

4. Select whether to make the wireless LAN settings.
Press [YES] to proceed to the access point setting.
For information on how to set up wireless LAN, see "9.2 Connecting via wireless LAN".
Press [NO] to go to the HOME screen.

WIRELESS LAN AVAILABLE. WANT TO SET IT UP NOW?	
YES	NO

Supplement

This screen will not be displayed if wireless LAN module is not installed.

5. Once the settings are confirmed, the HOME screen will be displayed.

2.6 Connecting to the Power

Turning on the power of the plotter.

Operation

1. Check that the power switch is turned off. (the "O" side is pressed down)

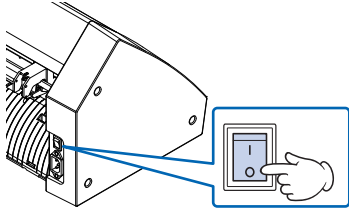

2. Connect one end of the provided power cord to the CE8000 AC line inlet and the other end to an electrical socket of the rated supply voltage.

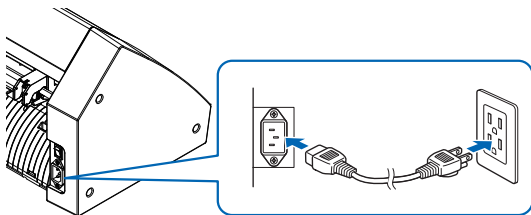

3. Turn on the CE8000 by pressing the "I" side of the switch. LCD on the control panel is lit.

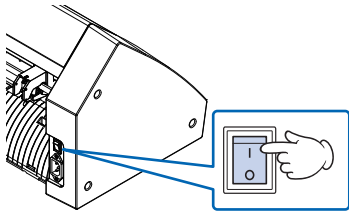

Supplement

When turning the power off, wait over 20 seconds before turning it on again, otherwise problems may occur with the display.

4. If media has not been loaded, the firmware version number is displayed, followed by a prompt to load media.

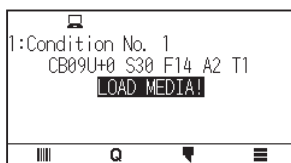

Media set lever raised
(The push roller is up)

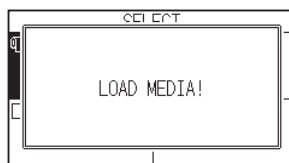

Media set lever lowered
(The push roller is down)

Supplement

The Default Screen will appear after purchasing the machine. See "2.5 About the Default Screen" for more information.

2.7 How to Use Control Panel

This section explains the function on the control panel.

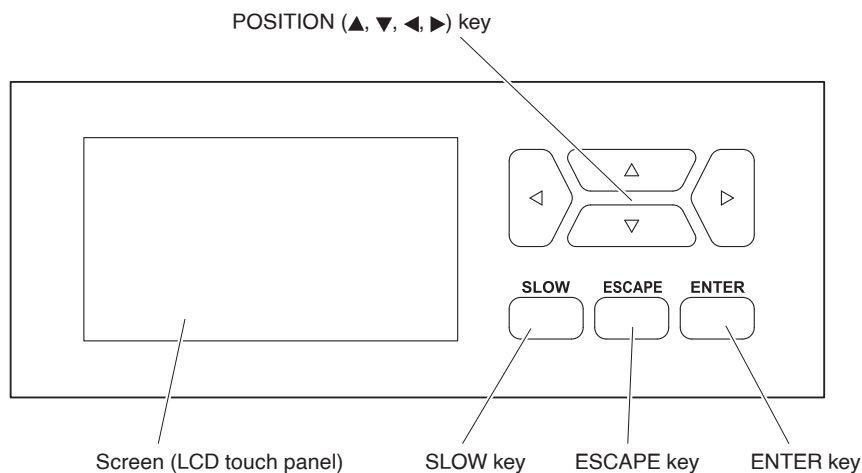

Operation key

POSITION (▲, ▼, ◀, ▶) keyAdjusts various settings, selects numerical value changes, moves the cursor, and changes the positions in the MENU screen.

SLOW key.....When pressing the POSITION key at the same time, the tool carriage moves slowly.

When the [SLOW] key is pressed in the READY screen, the current cutting/plotting area and the position of tool carriage are displayed.

If you want to change the cutting conditions while plotting/cutting, press the [SLOW] key while plotting/cutting.

ESCAPE key.....Cancels the setting change and then returns to the previous screen. Returns to the previous screen in the MENU screen.

If you want to temporarily stop plotting/cutting, press the [ESCAPE] key during plotting/cutting.

ENTER key.....Saves the settings, and then returns to the setting screen in various function or CONDITION setting screen of the MENU screen.

Control panel screens

Information according to the current situation is displayed on the control panel screen.

HOME screen



CONTINUOUS OPERATION START screen

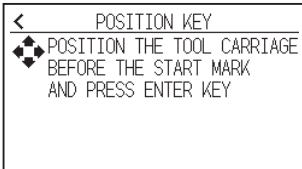

QUICK MENU screen

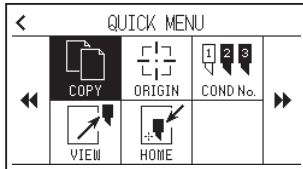

CUT CONDITION screen

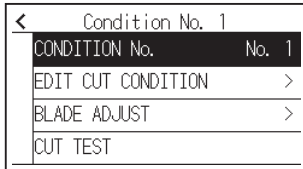

MENU screen

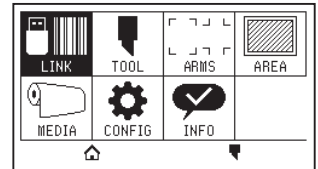

Media set lever lowered

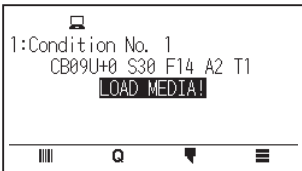

Media set lever raised

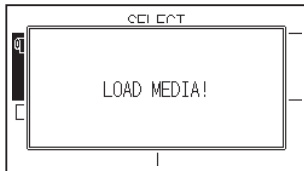

Setting status display

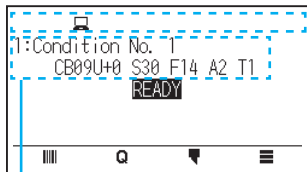

Tool conditions currently used

GLHL	Command	GL	: GP-GL Command
		HL	: HP-GL Command
		(No Display)	: Command Auto
.100 .050 .025 .010	Step size	.100	: 0.1mm
		.050	: 0.05mm
		.025	: 0.025mm
		.010	: 0.01mm
	Rotate/Mirror		: Rotation (Rotate 90°)
			: Mirror
			: Mirror and Rotate
	Priority		: Command priority
			: Menu priority
	Sort		: Display when sort is on
	Auto pre feed		: Display when AUTO PRE FEED is on
	WIRELESS LAN		: Wireless LAN connection signal strength (strong)
			: Wireless LAN connection signal strength (weak)
			: Wireless LAN connection disconnected

How to operate the control panel screen

You can operate this plotter using either the touch panel or operation keys.

How to operate the HOME screen (READY state)

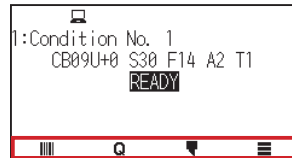

When using the touch panel

Use the [|||||], [Q], [▼] and [≡] icons.

When using the operation keys

Hold down the [ENTER] key and press the POSITION (◀, ▶) keys to select the [|||||], [Q], [▼] or [≡] icon. Release the [ENTER] key to move to each menu.

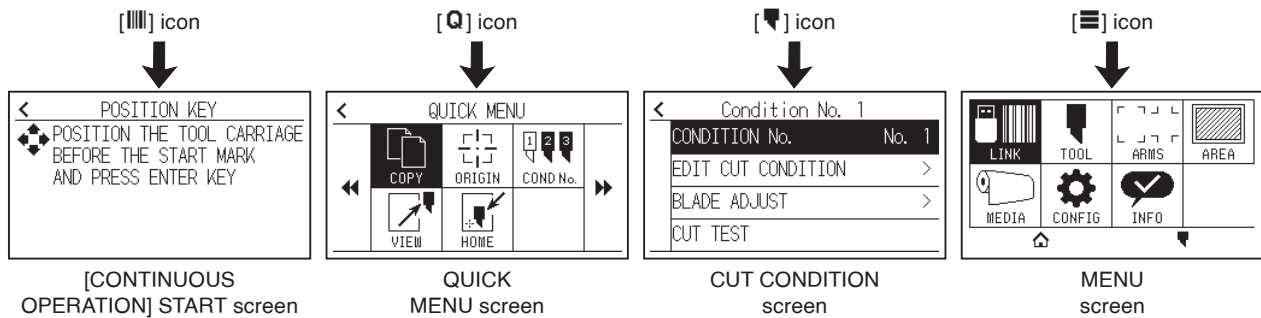

Supplement

There are screens other than the Home screen that have the above icons. Move to each menu by pressing the icon.

How to operate the MENU screen

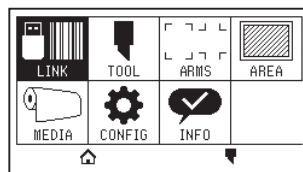

When using the touch panel

Press the icon.

When using operation keys

Select the icon using the POSITION (▲, ▼, ◀, ▶) keys. Press the [ENTER] key.

Contents to be operated from the [≡] icon - Menu screen

The contents that can be operated and set from the MENU screen are as follows.

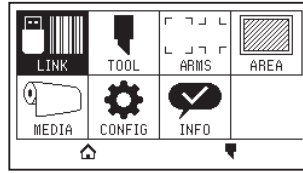

- LINK..... Performs operations necessary for output such as data links.
 - TOOL..... Sets the conditions related to tool operation.
 - ARMS Performs settings and operations related to alignment of tools and media, such as automatic registration mark scanning using ARMS.
 - AREA..... Sets the cutting plotting area, scale, rotation and mirror, etc.
 - MEDIA Sets the conditions related to media.
 - CONFIG..... Sets the basic operating conditions of this plotter, such as the display language, length unit and sensor.
Sets the conditions related to the interface with the connected computer.
 - INFO Performs operations necessary for maintenance, such as diagnostic test and exporting condition setting lists.
 - [🏠] Used to close the menu screen and to return to the home screen.
 - [⏴] Used to close the menu screen and to move to the condition screen.
- For a list of setting items, see "A.4 Menu Tree."

Contents to be operated from the [⏴] icon - CUT CONDITION screen

Set the tool conditions on the CUT CONDITION screen.

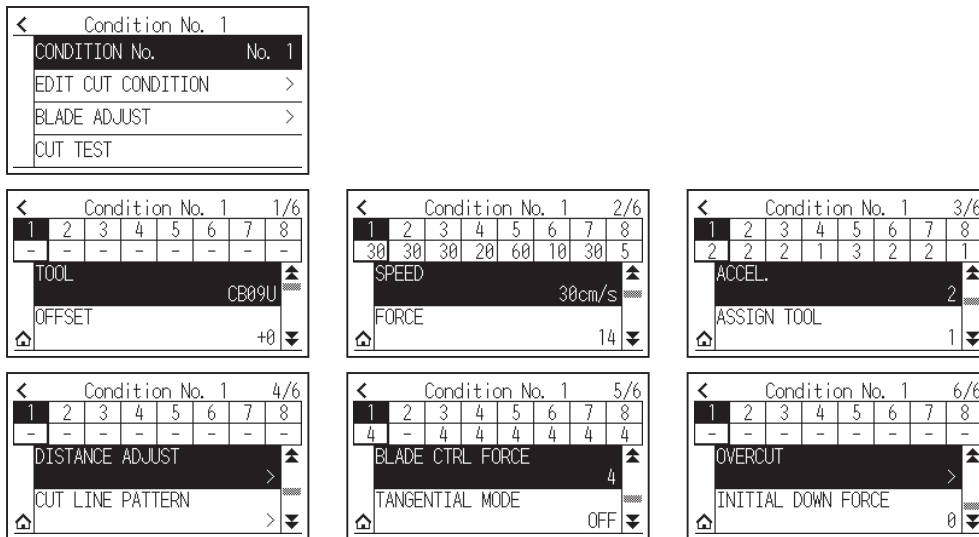

Tool conditions can be saved by assigning condition numbers 1 to 8 to each different setting.

- [🏠] Used to close the condition screen and to return to the HOME screen.
- [⏴] Used to close the CUT CONDITION screen and to return to the previous screen.

For "Tool Conditions", see "2.10 Setting the Tool Condition".

Contents to be operated from the [Q] icon - QUICK MENU screen

The contents that can be operated and set from the QUICK MENU screen are as follows.

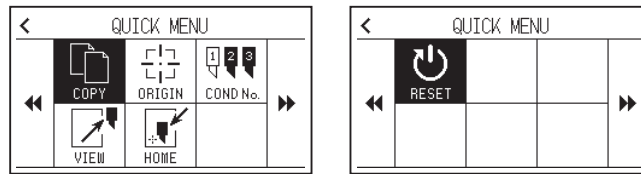

- COPY Copies and outputs data in buffer memory.
- ORIGIN..... Sets the current tool position as the origin point (cutting point).
- COND No. Changes the cutting condition number.
- VIEW The tool carriage is moved away.
- HOME..... The tool carriage moves to the cutting origin position.
- RESET..... Returns to the state immediately after power-on.

Contents to be operated from the [|||||] icon - [CONTINUOUS OPERATION] START screen

In the [CONTINUOUS OPERATION] START screen, the screen for starting continuous operation is displayed.

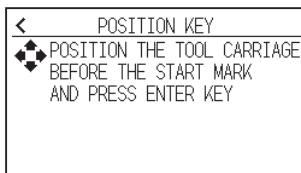

Supplement

Same operation as when [≡] - [LINK] - [CONTINUOUS OPERATION] are selected

How to operate the setting screen

This section describes using the [TOOLS SETTING] screen as an example.

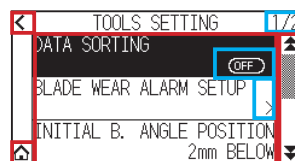

When using the touch panel

- Go back one level up: Press [←].
- Return to the HOME screen: Press [🏠].
- Return to previous page: Press [▲].
- Go to the next page: Press [▼].
- Select of setting items: Press each setting item.

When using operation keys

- Go back one level up: Press the [ESCAPE] key or POSITION (◀) key.
- Return to the HOME screen: Hold down the [ENTER] key and press the POSITION (◀) key, then select the [🏠] icon. Release the [ENTER] key to move to the HOME screen.
- Return to the previous page: Hold down the [SLOW] key and press the POSITION (▲) key.
- Go to the next page: Press the [SLOW] key.
- Selecting a setting item: Press the POSITION (▲, ▼) key to select the setting item, then press the [ENTER] key.

Supplement

- "1/2" at the top right of the screen is the page number.
- Setting items that display [OFF] or [ON] will be toggled between [OFF] and [ON] each time you press the setting item (press the [ENTER] key).
- Setting items with a [➤] icon have menus below them.

How to operate options

This section describes using the [TOOLS SETTING] - [INITIAL B. ANGLE POSITION] as an example.

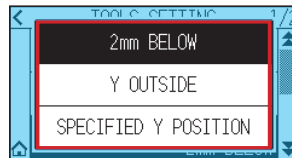

When using the touch panel

Press the setting item.

When using operation keys

Select the setting item using the POSITION (▲, ▼) keys. Press the [ENTER] key.

Supplement

You can cancel the settings by pressing outside the option popup screen or pressing the [ESCAPE] key.

How to operate numerical input

This section describes using the [MEDIA SETTING] - [PAGE LENGTH] as an example.

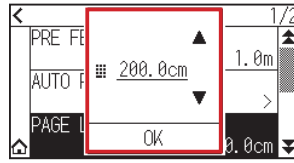

When using the touch panel

Press the [▲] [▼] icon or the [■] icon.

When you have finished entering the numerical values, press the [OK].

Supplement

- Press the [■] icon to display the numeric keypad.
Press the number you want to enter, then press the [OK].



- You can cancel the settings by pressing the numeric keypad outside the pop-up screen..

When using operation keys

Press the POSITION (▲, ▼) keys or the [SLOW] key.

When you have finished entering the numbers, press the [ENTER] key.

Supplement

- Press the [SLOW] key to display the numeric keypad.
Select the number you want to enter using the POSITION (▲, ▼, ◀, ▶) keys and press the [ENTER] key.
When you have finished entering the numbers, select the [OK] using the POSITION (▲, ▼, ◀, ▶) keys and press the [ENTER] key.



- Press the [ESCAPE] key to cancel the settings.

2.8 Setting Feeding Method

Feeding method for the loaded media is set.

Operation

1. If you have already loaded the media, the MEDIA TYPE menu appears. Select the media type to suit the loaded media.

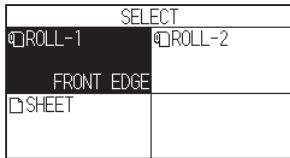

Check that the media stopper is unlocked (CE8000-60/CE8000-130) and then select a media type on the MEDIA SELECT screen.

* The figure below is CE8000-130.

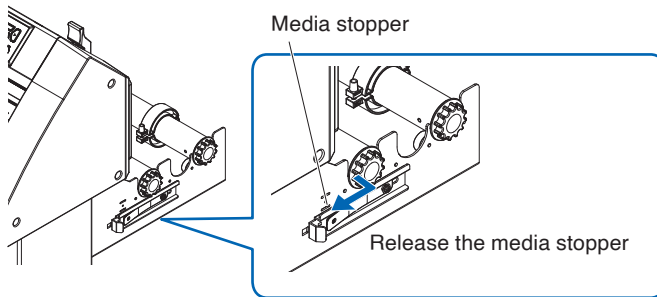

CAUTION

Before doing the media set selection, make sure to release the media lock.

Supplement

If you raise or lower the media set lever again after loading the media, [Continue] will be added and you can select the previous setting.

If you use the same media without changing its position, the cutting area, pen position and origin point before lowering the media set lever will continue. If you reload the media without changing the media width, you can omit the media width detection operation.

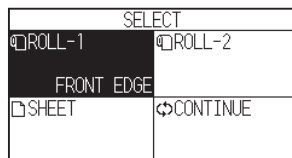

[ROLL-1 FRONT EDGE]

Select this when you have loaded a roll media and you wish to start cutting or plotting from the leading edge.

The width and leading edge of the roll media are detected.

[ROLL-2 CURRENT POSITION]

Select this when you have loaded a roll media and you wish to start cutting or plotting from a point beyond the leading edge.

Only the width of the roll media is detected.

[SHEET]

Select this when a sheet media has been loaded.

The width, leading edge, and trailing edge of the sheet media are detected.

2. After the media is detected, the plotter is ready to receive data for cutting or plotting. This status is called "READY status" of the default screen. When setting is finished, the tool carriage's location will become the initial point.



Supplement

- When loading the media, the fan suction operates to assist in loading the media. If you want to turn off this function, please refer to "10.3 Related to Plotter Environment".
- The following screen will be displayed while media is being detected.

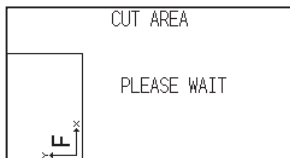

2.9 Pre Feed of Media (Paper or Marking Film)

The PRE FEED function is used to prevent the loaded media from slipping by automatically advancing the media the specified length and imprinting it with grit roller marks. This function can also be used to acclimate long media lengths to the operating environment in order to minimize media expansion and contraction, and to ensure stable media feed operations.

When performing plotting/cutting longer than 2 m in CE8000-60/130, be sure to use a basket (option).

Operation

1. Press the [≡] icon.



2. Press the [MEDIA] icon.

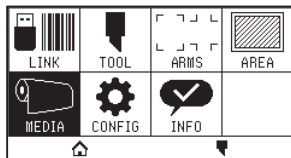

3. Press the [PRE FEED].

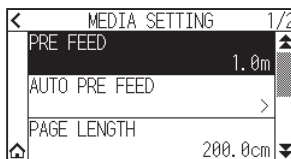

4. Specify the setting value using the [▲] [▼] icon or the [≡] icon.

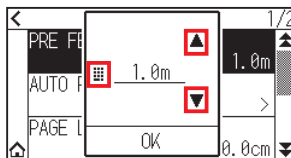

Supplement

You can set the range between 0.5 m and 50 m.

5. Confirm the setting and press the [OK].
Pre feed will start.

Supplement

- When Pre Feed of Media is performed, the following screen is displayed.
To cancel the Pre Feed, press the [CANCEL].

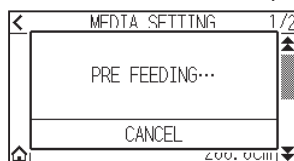

- If you select "SHEET" in the media feeding, the Pre Feed will not be performed.

2.10 Selecting Tool Condition

Set the “TOOL CONDITION (CUT CONDITION) No.,” “TOOL,” “OFFSET,” “SPEED,” “FORCE,” and “ACCEL (ACCELERATION)”.

You can switch to the settings for each of the 8 preset media types.

Selecting the TOOL CONDITION number (Condition No.)

This section explains how to select the TOOL CONDITION number (Condition No.).

Operation: Operation with the [▼] icon

1. Press the [▼] icon.



2. Press the [CONDITION No.].

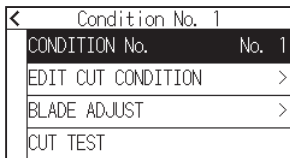

3. Use the [▼] and [▲] icons to display the tool condition number you want to use.

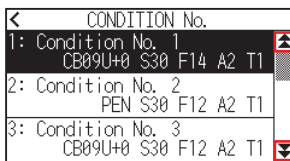

4. Press the tool condition number you want to use.
5. Press the [◀] icon.
▶ It will return to HOME screen.

Operation: Operation with the [Q] icon

1. Press the [Q] icon.

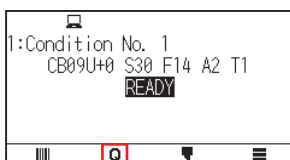

2. Press the [COND No.] icon.

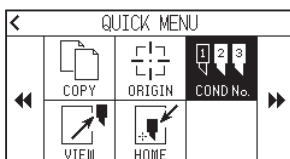

- Use the [▼] and [▲] icons to display the tool condition number you want to use.

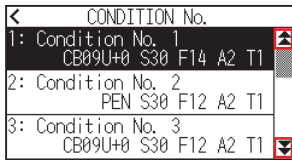

- Press the tool condition number you want to use.

▶ It will return to HOME screen.

Setting the tool condition

This section describes how to make the tool, speed, force and acceleration settings.

Before cutting media, the following four cutter-pen conditions must be specified.

- FORCE
- SPEED
- ACCELERATION
- OFFSET

CAUTION

It may result to damaging the cutter blade or the cutting mat if the blade is extended too much. Make sure the blade length is set less than the thickness of the media.

Tool Conditions (Cutter Blade) for Each Media Type

See the Cutter Blade Manual.

Blade Part Nos., Displayed Blade Types, and CUTTER OFFSET Values

See the Cutter Blade Manual.

Reference Pen Conditions for Plotting Pen

Pen type	Part no.	Cut/Force	Speed (cm/s)	Acceleration
Water-based fiber-tip pen	KF700 series	10 to 12	30	2
Oil-based ballpoint pen	KB700-BK	12 to 31	30	2

To prolong the pen life, set the FORCE to the lowest setting, and set the SPEED after checking to confirm that there are no faint lines or other problems during plotting.

CAUTION

How to Improve Weed ability

We recommend that you observe the following points to improve the weed ability of media.

- Select the correct blade for the application.
See the Cutter Blade Manual.
- Use blades that are not worn.
If the blade is worn, it will not cleanly and the cut results will be difficult to weed.
- Adjust the blade-length and FORCE settings until only traces of the blade are left on the backing sheet.
Specify a FORCE value that is as low as possible, but that still leaves faint traces on the backing sheet.
- Set the SPEED and ACCELERATION values as low as possible.
- Weed the cut results right after cutting has been completed.
If time is allowed to elapse, adhesive along the cut edges will cause the edges to stick together.
- Select media with good weldability.
Recommended film types: 3M Scotchcal Series 7725.
Weeding refers to the removal of un wanted areas of vinyl from the background after the media has been cut.

- Finish will become coarser, but the cut time is decreased when the settings for the speed and acceleration is set higher.
Especially with the large media, good cut quality might not be achieved by rumbling media. Decrease the values for the speed and acceleration settings in that case.
- Finish will become good, but the cut time will increase when the settings for the speed and acceleration is set smaller.
- If you try to set speed 64 and acceleration 3 at the same time on CE8000-40/60, the acceleration will be displayed as " * ".
In this case, the speed and acceleration settings will operate with automatically calculated values.
- If the acceleration is 2 for CE8000-130, the speed cannot be set to 65 or higher (65, 70, 71).
In this case, the acceleration will be displayed as " * " and the speed and acceleration settings will operate with automatically calculated values.

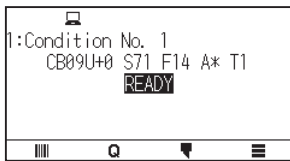

Setting the tool

Set the type value of the tool that is used.

Operation

1. Press the [] icon.



2. Press the [EDIT CUT CONDITION].

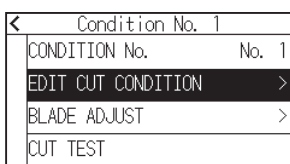

3. Press the tool condition number (1 to 8) you want to set.

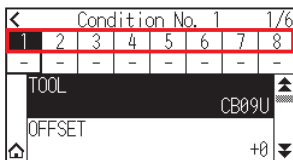

4. Press the [TOOL].

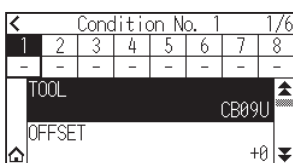

- Use the [▼] and [▲] icons to display the tools you want to use.

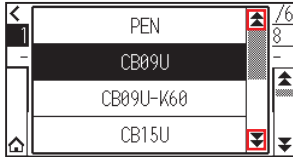

- Press the tool you want to use.

Supplement

The tools that you can select are [PEN], [CB09U], [CB09U-K60], [CB15U] and [OTHER].

- Press the [HOME] icon.
▶ It will return to HOME screen.

Tool offset setting

This section describes how to set the tool offset you want to use.

Operation

- Press the [▼] icon.

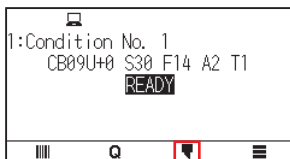

- Press the [EDIT CUT CONDITION].

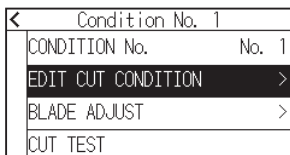

- Press the tool condition number (1 to 8) you want to set.

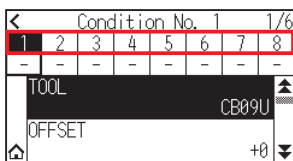

- Press the [OFFSET].

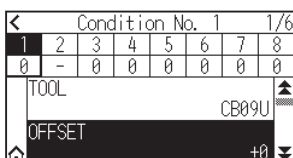

- Specify the setting value using the [▲] [▼] icon or the [⌂] icon.

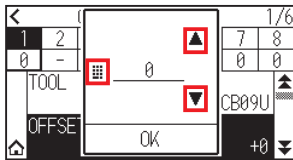

Supplement

- What is Offset

It will adjust the difference between the tip of the blade in the plunger and the center of the plunger. There are standard adjustment values for each cutter blades. Fine adjustment will be made to those standard values here. (Adjustment will be made with standard value as 0.)

It is not necessary to set the offset if "PEN", was selected in the tool settings. (not displayed)

- Guideline to Set Offset

See the Cutter Blade Manual

- The range that can be set with the tool other than [OTHER] is [-5] to [+5].

The range that can be set in [OTHER] is [+1] to [+45].

- Confirm the setting and press the [OK].

- Press the [⌂] icon.

▶ It will return to HOME screen.

Setting the speed

This section explains how to set the speed to be used.

Operation

- Press the [▼] icon.

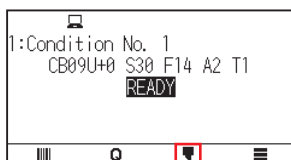

- Press the [EDIT CUT CONDITION].

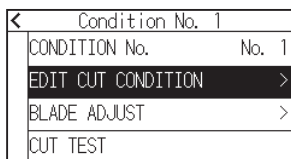

- Press the [▼] icon.

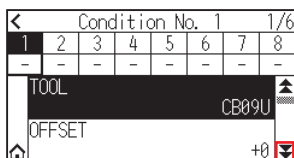

- Press the tool condition number (1 to 8) you want to set.

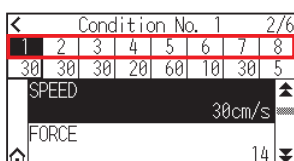

5. Press the [SPEED].

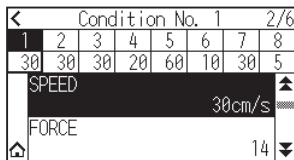

6. Specify the setting value using the [▲] [▼] icon or the [] icon.

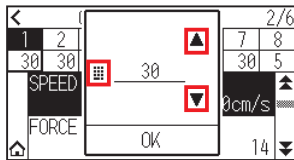

Supplement

The settable range varies depending on the model.
 CE8000-40: 1 to10 (in 1 cm/s increment), 10 to 60 (in 5 cm/s increment), 64
 CE8000-60: 1 to10 (in 1 cm/s increment), 10 to 60 (in 5 cm/s increment), 64
 CE8000-130: 1 to10 (in 1 cm/s increment), 10 to 70 (in 5 cm/s increment), 71

7. Confirm the setting and press the [OK].
8. Press the [HOME] icon.
 ► It will return to HOME screen.

Setting the force

This section explains how to set the force to be used.

Operation

1. Press the [] icon.

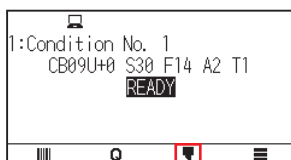

2. Press the [EDIT CUT CONDITION].

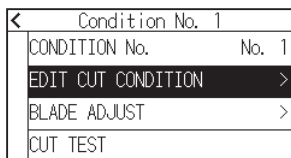

3. Press the [▼] icon.

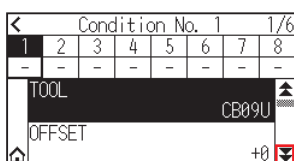

- Press the tool condition number (1 to 8) you want to set.

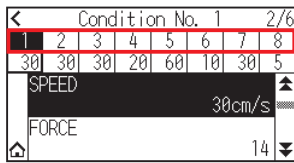

- Press the [FORCE].

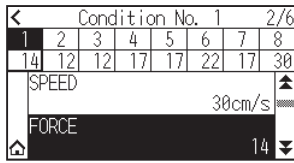

- Specify the setting value using the [▲] [▼] icon or the [] icon.

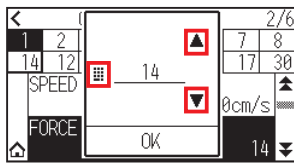

Supplement

You can set the range between 1 and 38.

- Confirm the setting and press the [OK].
- Press the [HOME] icon.
▶ It will return to HOME screen.

Setting the acceleration

This section explains how to set the acceleration to be used.

Operation

- Press the [] icon.



- Press the [EDIT CUT CONDITION].

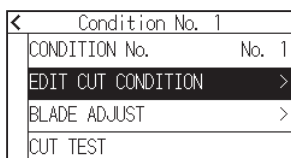

- Press the [▼] icon twice.

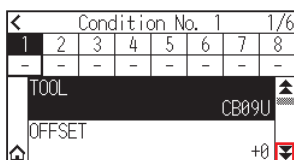

- Press the tool condition number (1 to 8) you want to set.

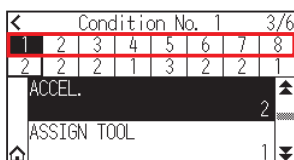

- Press the [ACCEL. (Acceleration)].

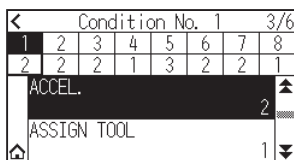

- Specify the setting value using the [▲] [▼] icon or the [⌘] icon.

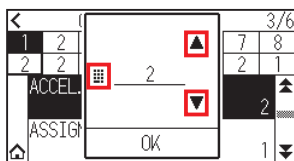

Supplement

The settable range varies depending on the model.

CE8000-40: 1 to 3

CE8000-60: 1 to 3

CE8000-130: 1 to 2

- Confirm the setting and press the [OK].

- Press the [HOME] icon.

▶ It will return to HOME screen.

Setting tool No.

This section explains how to assign the tool number to use.

Operation

- Press the [EDIT CUT CONDITION] icon.

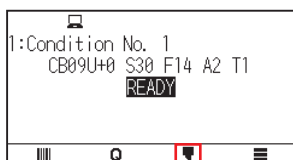

- Press the [EDIT CUT CONDITION].

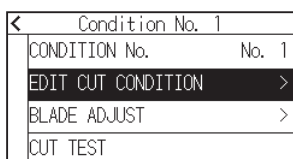

3. Press the [▼] icon twice.

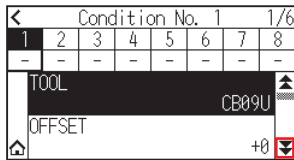

4. Press the tool condition number (1 to 8) you want to set.

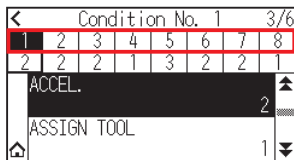

5. Press the [ASSIGN TOOL].

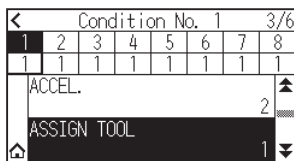

Supplement

You can set to 1 or 3.

6. Press the tool number you want to use.

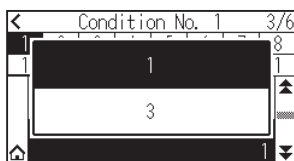

7. Press the [HOME] icon.

▶ It will return to HOME screen.

Supplement

- Tool number and installed position

Tool 3: For cutting out

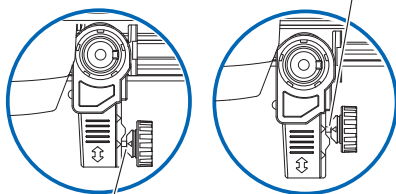

Tool 1: For half cut/plotter pen

Tool 1: When using a tool installed behind the tool holder

Tool 3: When using a tool installed in front of the tool holder

- For information on how to install the tool, see "2.2 Attaching a Tool".

Adjust the blade length manually

Optimal cut is not achieved unless the blade length is adjusted in accordance to the used media and the cutter blade.

Perform further adjustment by performing cutting test after adjusting the blade length manually.

CAUTION

- To avoid bodily injury, handle cutter blades with care.
- It may result to damaging the cutter blade or the cutting mat if the blade is extended too much. Make sure the blade length is set less than the thickness of the media.

Supplement

See "2.11 Running Cutting Tests" for cutting tests.

Operation

1. Align the blade tip to the tip of the cutter pen, and make it touch the surface of the media.

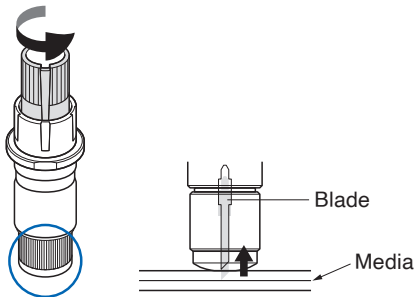

2. Extend the blade little by little to the thickness of the media.
Optimal blade length is less than the thickness of film and backing sheet combined, but more than the thickness of the film.
Try cutting the film, and adjust so there is slight cutting on the backing sheet. If the backing sheet gets cut completely, reduce the blade length, and if the film does not get cut completely, increase the blade length.

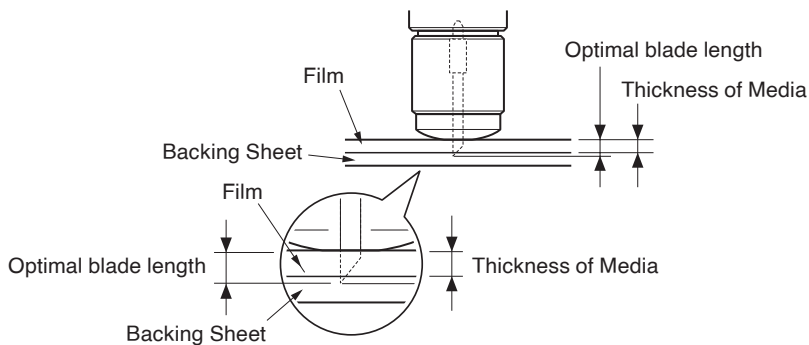

Supplement

- Blade length can be changed by spinning the adjuster on the blade. Spinning it in the A direction pushes it out, while spinning it in the B direction pulls it in. One scale unit is equal to 0.1 mm.

Cutter blade moves approximately 0.1 mm turning one scale unit.

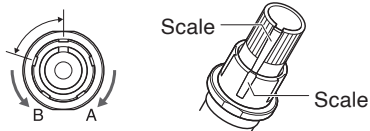

2.11 Running Cutting Tests

Test cutting can be performed after making the tool, speed, force, and acceleration settings to ensure that the selected cutting conditions actually produce the desired cutting results. Check how far the blade cuts into the media and how the corners are being cut. If the cutting results are not satisfactory, adjust the various settings and repeat the test cutting until the optimal settings are achieved.

Cutting test

Here, you can either cut one test pattern based on the current values, or do three tests with ± 1 values added. Select the method that suits your situation and make a cutting test.

To make 1 cut with set value

Operation

1. Load the actual media you want to cut.
2. Press the [] icon.

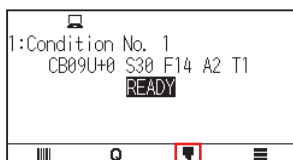



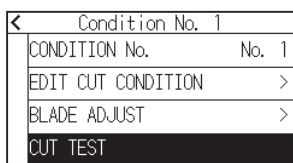

3. Press the [CUT TEST].

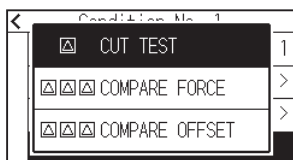

4. Press the [CUT TEST].



5. Press the POSITION (, , , ) keys to move the tool carriage to the location you wish to perform the test

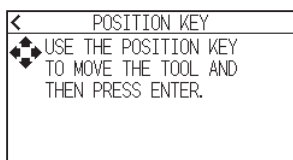

Supplement

Pressing the POSITION and [SLOW] keys at the same time will move the tool carriage slower.

- Press the [ENTER] key.
▶ 1 cut test pattern is cut.

⚠ CAUTION

When the [ENTER] key is pressed, the tool carriage will start moving, so take care not to get injured by the cutter blade.

- Check the test cut results.
- Press the [OK] or [ENTER] key.

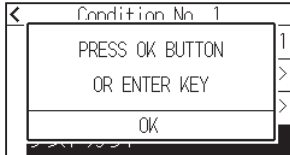

- Press any position outside the option (blue part).

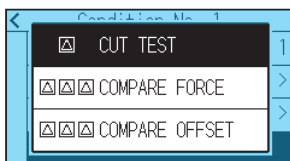

- Press the [←] icon.
▶ It will return to HOME screen.

To make 3 cuts with set value and ±1 of set value

Operation

- Load the actual media you want to cut.
- Press the [▼] icon.

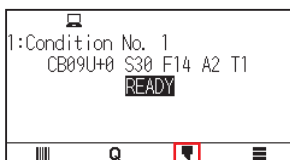

- Press the [CUT TEST].

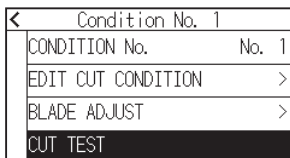

- If you want to perform a cutting force test, press the [COMPARE FORCE].
If you want to perform an offset test, press the [COMPARE OFFSET].

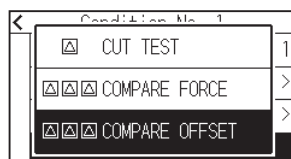
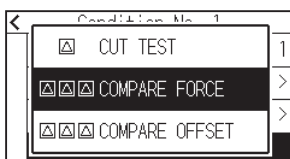

5. Press the POSITION (▲, ▼, ◀, ▶) keys to move the tool carriage to the location you wish to perform the test cutting.

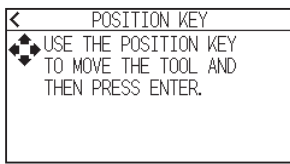

Supplement

Pressing the POSITION and [SLOW] keys at the same time will move the tool carriage slower.

6. Press the [ENTER] key.
 - ▶ If you perform [COMPARE FORCE], three cut test patterns will be cut one with the cutting force increased or decreased by 1 based on the current cutting force.
 - ▶ If you perform [COMPARE OFFSET], three cut test patterns will be cut one with the offset value increased or decreased by 1 based on the current offset value.

CAUTION

When the [ENTER] key is pressed, the tool carriage will start moving, so take care not to get injured by the cutter blade.

Supplement

The cut test pattern has the cut order and cut force or offset increase/decrease value as shown in the figure below.

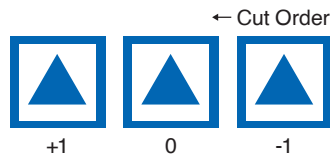

7. Check the test cut results.
8. Press the [OK] or [ENTER] key.

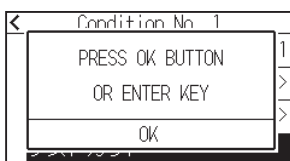

9. Press any position outside the option (blue part).

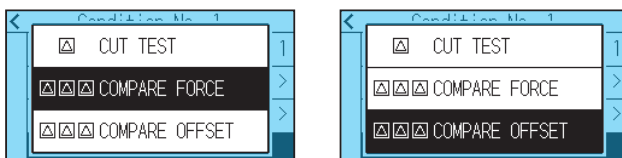

10. Press the [◀] icon.
 - ▶ It will return to HOME screen.

Confirm the results of the cutting test

Confirm the cutting test results, and adjust to optimal setting. Repeat cutting test and adjustment until optimal cut is achieved.

Adjustment of Offset

Check the corners of the triangles and rectangles. See "Setting the Tool Condition" and adjust the offset value if the corner is not cut or if it is cut too much.

Supplement

How to check offset

Check if the offset value is set correctly by following.



Not enough adjustment value. Increase the offset value.



Optimal offset value.



Too much adjustment value. Decrease the offset value.

Adjustment for Half Cutting

Peel off the triangle area, and adjust so it cuts slightly into the backing sheet.

If the backing sheet has been cut through, either the FORCE setting is too high or the cutter-blade tip is extended too far. If the backing sheet shows only a few traces of the cutter blade, either the FORCE setting is too low or the cutter blade tip is not sufficiently extended.

Supplement

See "Adjusting the Blade Length" and "Setting the Force" and adjust the settings.

Adjustment for cutting out

Adjust so the media is completely cut out.

If the media is not completely cut, either the FORCE setting is too low or the cutter blade tip is not sufficiently extended.

See "Adjusting the Blade Length" and "Setting the Force" and adjust the settings.

Adjustment when using plotting pen

Adjust the FORCE so there will be no faint lines. To prolong the pen life, set the FORCE to the lowest setting without any faint lines. See "Setting the Force" or setting the FORCE.

Adjust the blade length (Automatic Height Adjust)

Test cutting must be performed several times in order to confirm the optimal blade length setting. However, if the blade length adjustment function is used, the optimal length can be easily set.

Supplement

The measured height is a guideline only. After attempting to cut the actual media, please adjust blade length accurately.

For more accurate adjustment, please use a Loupe (PM-CT-001: option).

Operation

1. Load the media for test cutting in the plotter.
2. Press the POSITION (▲, ▼, ◀, ▶) keys to move the tool carriage to the location you wish to perform the blade length adjustment.
3. Press the [] icon on the HOME screen.



4. Press the [BLADE ADJUST].

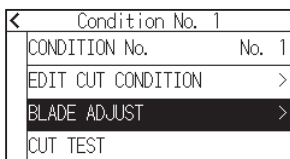

5. As instructed, turn the blade length adjustment knob to the left to fully retract the blade.

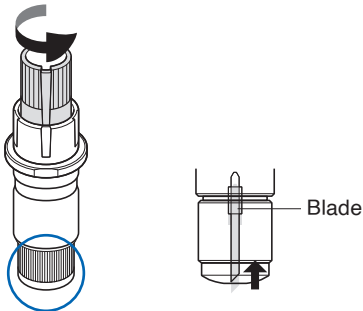

Supplement

See "2.1 Preparation of Cutter Plunger" for blade length adjustment knob.

6. Set the cutter plunger in backward of Tool Holder.

Supplement

Adjustment is only possible for the cutter pen set in backward of Tool Holder.
It does not apply to forward of Tool Holder.

- Press the [START].
▶ The tool moves down/up and measures the height.

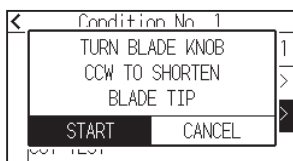

- Press the [TARGET].

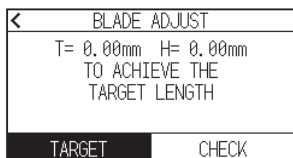

- Specify the target value using the [▲] [▼] icon or the [■] icon.

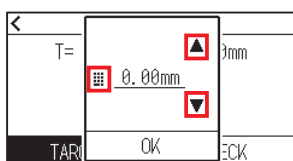

- Confirm the setting and press the [OK].

- Press the [CHECK].

▶ The height is calculated by moving the tool up and down.

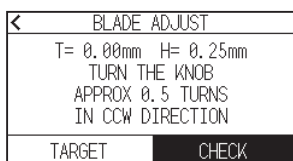

Supplement

"T" is the target value of the blade length, and "H" is the current blade height (amount).
Turning the blade-length adjustment knob displays the number of turns and direction.

- Turn the blade-length adjustment knob and adjust the cutter blade length.
Current blade length is displayed by pressing the [CHECK], so adjust the blade length until it matches the thickness of the media.

CAUTION

Depending on the media type, the blade might sink in to the media, making accurate measurement impossible.

- Press the [◀] icon twice.

▶ It will return to HOME screen.

2.12 Displaying Cutting Area

Check the cutting area.

Operation

1. Press the [SLOW] key in the HOME screen.

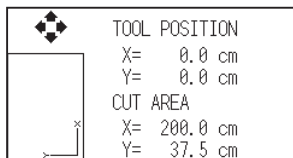

Supplement

The [TOOL POSITION] indicates the current tool position in the cutting area.

2. Release the [SLOW] key.
▶ It will return to HOME screen.

Chapter 3: Basic Operations

This chapter describes the basic methods to operate the plotter manually.

SECTION IN THIS CHAPTER

- 3.1 Raise or Lower the Tool*
- 3.2 Move the Tool Carriage*
- 3.3 Setting the Origin Point*
- 3.4 Setting the Cutting Direction*
- 3.5 Stop Cutting*

3.1 Raise or Lower the Tool

This is a function to raise or lower the tool.

Operation

1. Press the [≡] icon.



2. Press the [TOOL].

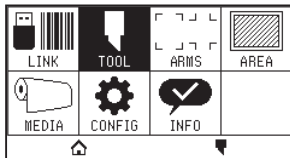

3. Press the [▼] icon.

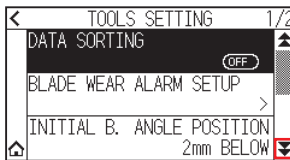

4. Press the [TOOL UP/DOWN]. Tool is raised or lowered every time the [TOOL UP/DOWN] is pressed.

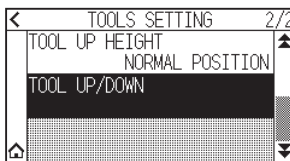

5. Press the [HOME] icon.

▶ It will return to HOME screen.

3.2 Move the Tool Carriage

Tool carriage can be moved manually using the POSITION key.

It can move the tool carriage to the origin, or move it certain distance to keep it away.

Move in steps manually

It can manually move in steps when the screen is displaying "READY", or when the POSITION (▲, ▼, ◀, ▶) key is displayed.

Operation

1. Press the POSITION (▲, ▼, ◀, ▶) key once to move in the desired direction.
▶ Tool carriage or the media will move toward the direction of the pressed POSITION key for 1 step.

Supplement

- It will move in steps every time POSITION (▲, ▼, ◀, ▶) key is pressed.
- Distance of step movement can be changed. See "3.2 Move the Tool Carriage".

Continuously move manually

It can manually move continuously when the screen is displaying "READY", or when the POSITION (▲, ▼, ◀, ▶) keys are displayed.

Operation

1. Hold the POSITION (▲, ▼, ◀, ▶) key down to keep moving in the desired direction.
▶ Tool carriage or the media keeps on moving continuously in the direction of the pressed POSITION key.

Supplement

Pressing the POSITION and [SLOW] keys at the same time will move the tool carriage slower.

2. Release the POSITION (▲, ▼, ◀, ▶) key.
▶ Movement of the tool carriage or the media will stop.

Setting step movement distance

The parameters when setting the cutting direction are determined by the distance of the cutting direction.

Operation

1. Press the [≡] icon.



2. Press the [CONFIG].

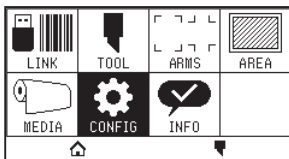

3. Press the [GENERAL].

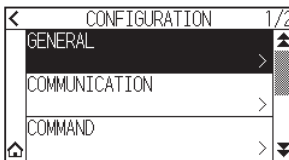

4. Press the [↓] icon.

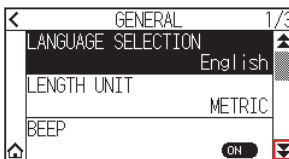

5. Press the [MOVE STEP].

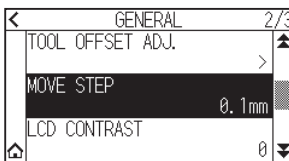

6. Press the move step you want to use.

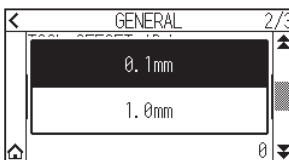

Supplement

Value chosen here will be the movement distance for the step movement.

7. Press the [HOME] icon.

▶ It will return to HOME screen.

Move away the tool carriage

It is possible to move the tool carriage toward upper right.

It makes it easier to confirm the cutting results if you perform this operation after the cutting is completed.

<When using Roll Media>: Seen from above

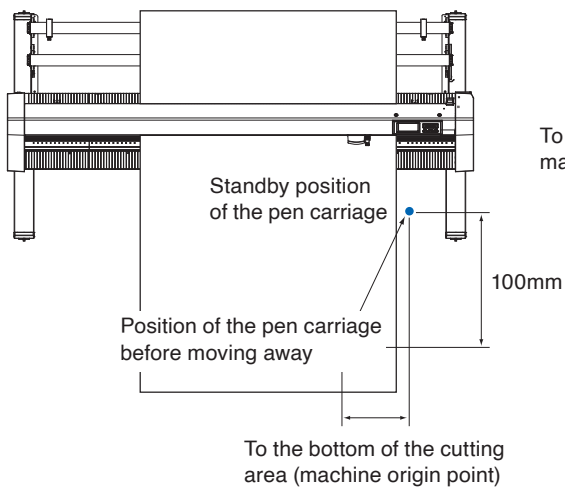

<When using Sheet Media>: Seen from above

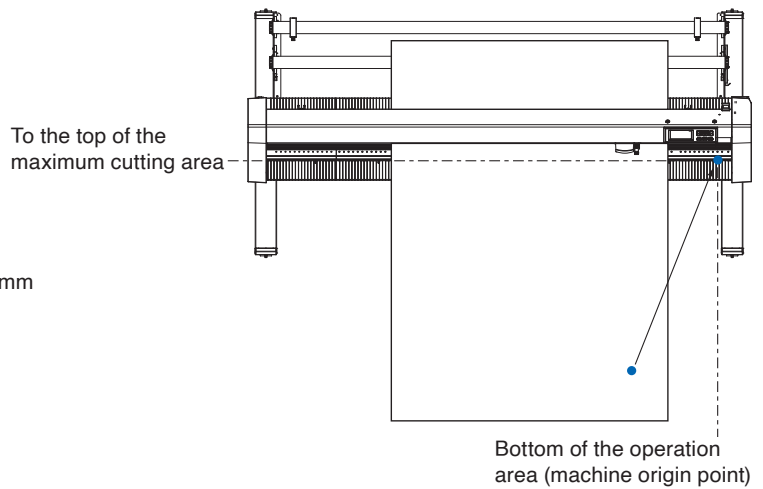

Operation

1. Press the [Q] icon.

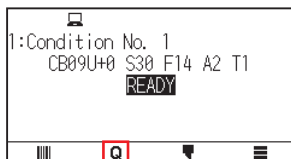

2. Press the [VIEW].

▶ Tool carriage will move away.

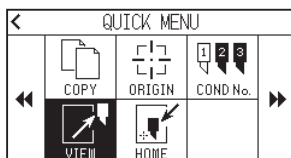

3. Press the [HOME].

▶ Tool carriage will move to the origin point.

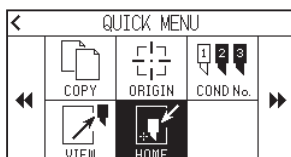

Reset (Revert to the initial state when the power was turned on.)

Revert to the initial state when the power was turned on.

Operation

1. Press the [Q] icon.

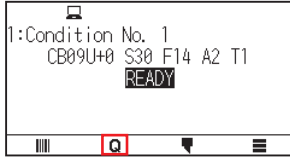

2. Press the [▶▶] icon.

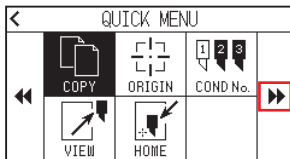

3. Press the [RESET].

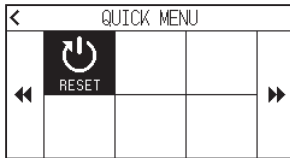

4. Press the [YES].

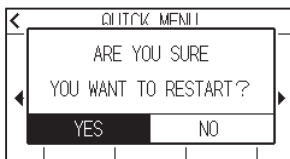

3.3 Setting the Origin Point

Point where the plotting starts is called origin point. The origin point can be set at any location.

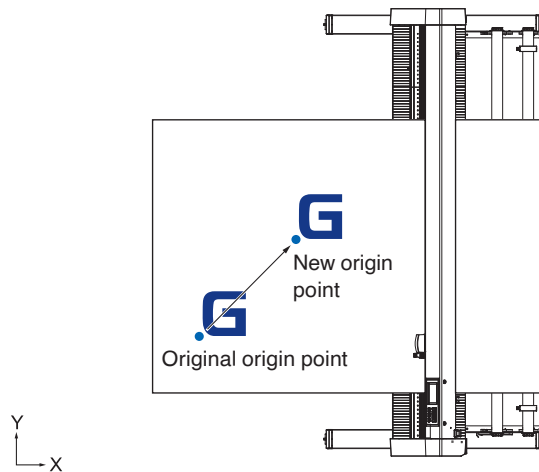

How to set the current position to the new origin point

1. Move the tool to the new origin point by pressing the POSITION (▲, ▼, ◀, ▶) keys when it is in READY status.

2. Press the [Q] icon.

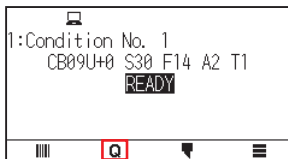

3. Press the [ORIGIN].

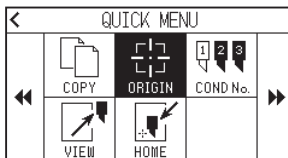

4. "NEW ORIGIN POINT IS SET!" is displayed for few seconds in the screen.



When coordinate axes rotation are set

If the origin point is moved while the coordinate axes are rotated, the origin point will move as shown below.

Supplement

See "3.4 Setting the Cutting Direction" about the rotation of the coordinate axes.

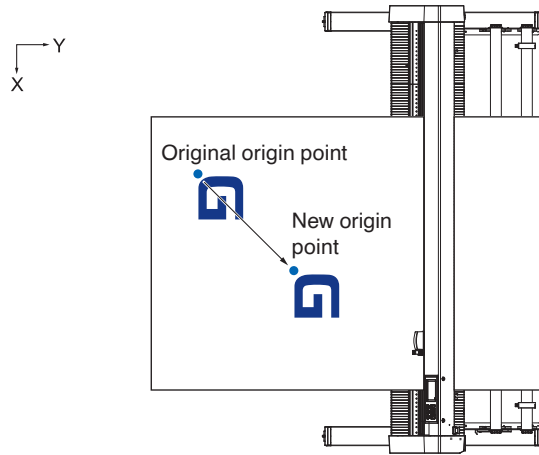

When coordinate axes are rotated after origin point is set

The origin point will be initialized as shown below if the coordinate is rotated after moving the origin point. Distance "a" will be maintained, but distance "b" will be initialized.

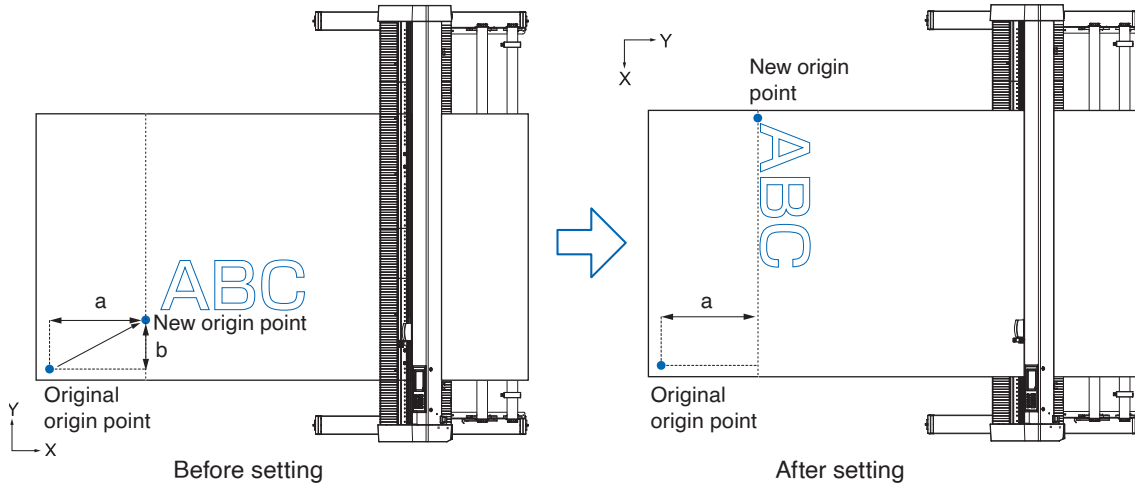

Supplement

- To use the origin point movement and coordinate axes rotation together, always rotate the coordinate axes first, and then move the origin point.
- Coordinate value displayed after setting new origin point is a distance from the new origin point.

Setting origin point when HP-GL is set

When using the HP-GL command, the origin point is set to either the lower left of the cutting area or the center.

Supplement

- When using the GP-GL command, this setting does not affect the operation.
- See "Chapter 11 Settings of Controls from Computer" for setting the COMMAND.

Operation

1. Press the [≡] icon.

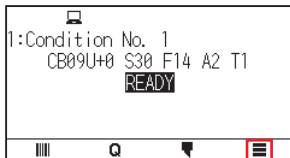

2. Press the [CONFIG].

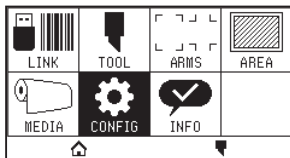

3. Press the [COMMAND].

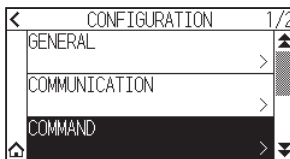

4. Press the [HP-GL ORIGIN POINT].

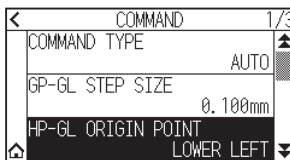

5. Press the origin position you want to use.

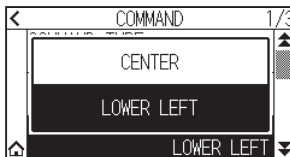

6. Press the [HOME] icon.

▶ It will return to HOME screen.

3.4 Setting the Cutting Direction

Rotate the coordinate axes to change the cutting direction.

Supplement

The rotation settings will be saved even if the power is shut off.

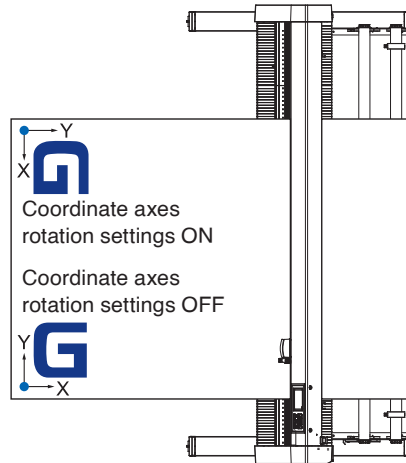

Operation

1. Press the  icon.

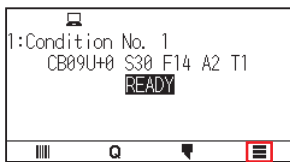

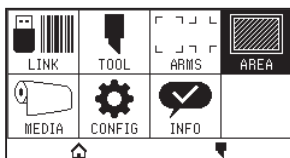

2. Press the [AREA].

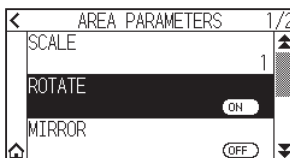

3. Press [ROTATE] to turn it to [ON].

▶ To cancel, set it to [OFF].



4. Check the settings and press the  icon.
5. The tool carriage moves to the set coordinate position.

3.5 Stop Cutting

It will stop cutting during operation.

The menu is displayed on the screen of the control panel while it is stopped. It is possible to choose either to continue or stop the operation.

It is also possible to exchange or reset the media while it is stopped.

Pause and resume cutting

Operation

1. Press the [STOP] or [ESCAPE] key.

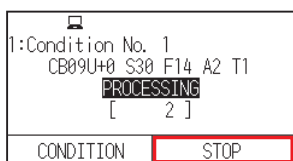

2. Perform necessary operation, such as exchanging the media.

Supplement

There is no effect on the selection of media type when the media set lever is moved up and down while pausing the cutting. It is also possible to exchange or reset the media.

3. Press the [RESUME JOB].

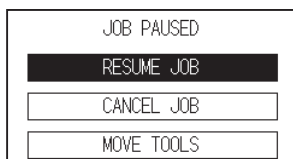

Supplement

Press the [CANCEL JOB] to cancel the cutting.

Stop cutting

Operation

1. Press the [STOP] or the [ESCAPE] key.

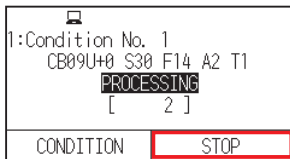

2. Press the [CANCEL JOB].

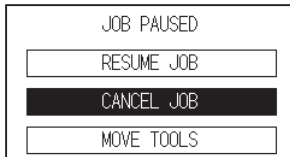

Supplement

It will resume cutting by pressing the [RESUME JOB].

3. Confirm if the data transfer from the computer is stopped and press the [YES, CLEAR].

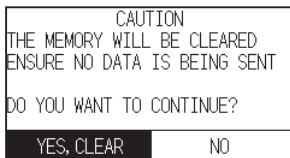

▶ The buffer memory will be cleared and it will return to HOME screen.

Supplement

- If you press the [NO], you will return to the work interruption screen without clearing the buffer memory.
- When clearing the buffer memory, be sure to make sure that data transfer has stopped.
If you clear the buffer memory while data is being transferred, processing will start from the middle of the data, which may result in abnormal operation.

Chapter 4: Convenient Functions

This chapter describes about the convenient functions of the plotter.

SECTION IN THIS CHAPTER

4.1 Settings for Cutting

4.2 Copy (Duplicate Cutting)

4.3 Panel Cutting

4.1 Settings for Cutting

Settings such as area and width of cutting, page length, mirrored, enlarged, shrunk, etc., can be set.

Setting cutting area

Origin point will be set at lower left of the AREA once the AREA is set.
It is possible to set the origin point at the center when the HP-GL is selected.
Move the origin point to change the cutting position.

Supplement

See "3.3 Setting the Origin Point " for the moving the origin point, and origin point using the HP-GL command.

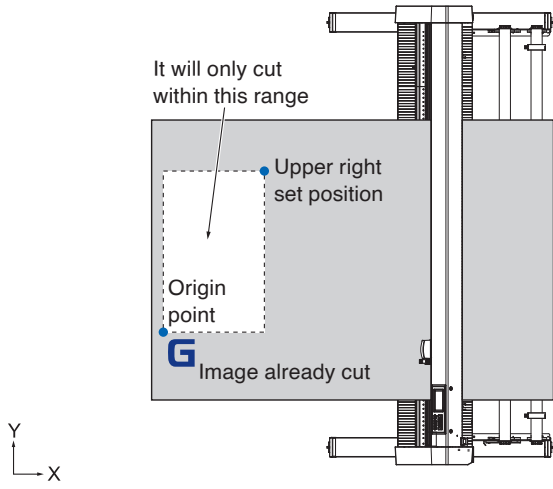

Operation

1. Press the [≡] icon.



2. Press the [AREA].

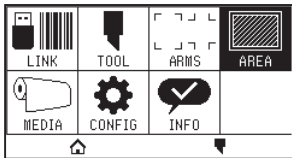

3. Press the [▼] icon.

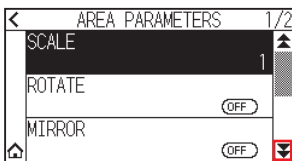

4. Press the [AREA].



5. Press the [TOOL MOVE].

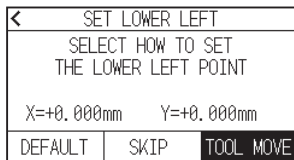

Supplement

- Coordinate value displayed here is the distance to the tool carriage from the origin point.
- Press [DEFAULT] if the cutting area is not to change.

6. Press the POSITION (▲, ▼, ◀, ▶) keys and move the tool carriage to the position to be the lower left of the cutting AREA.

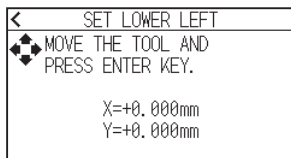

7. Press the [ENTER] key once the tool carriage is in correct position.

8. Press the [TOOL MOVE].



9. Press the POSITION (▲, ▼, ◀, ▶) keys and move the tool carriage to the upper right position of the cutting area.

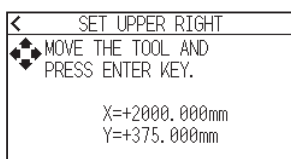

Supplement

Please set the X and Y cut range for the areas on the upper right and lower left points to at least 10 mm. An error message will appear for areas that are too small. You will need to reset the settings for the upper right and lower left points.

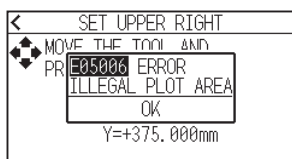

10. Press the [ENTER] key once the tool carriage is in correct position.

11. Press the [HOME] icon.

▶ It will return to HOME screen.

Setting cutting width (EXPAND)

Set the width of the cutting area.

Default setting is to the internal edge of the push rollers.

It can be set up to 10 mm outside (positive value).

Setting will affect both ends, resulting the total width change will be double the set value.

CAUTION

Do not set the "INITIAL B. ANGLE POSITION" of the tool setting to "Y OUTSIDE" when the setting value is set to more than 8 mm. The blade might be damaged by moving the carriage outside the media under this condition.

Supplement

- If the value is set, it is able to cut over where the push rollers are, but the push rollers passes where it is cut, creating a chance of bad feeding depending on the media.
- Set the width of cutting area, and then send the cutting data to the plotter.
Cutting data in the buffer memory will be cleared when cutting area width is changed.

Operation

1. Press the [≡] icon.

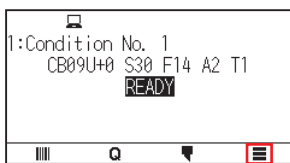

2. Press the [AREA] key.

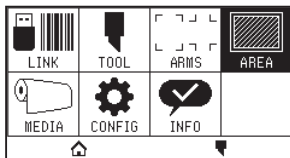

3. Press the [▼] icon.

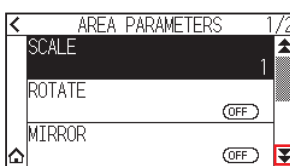

4. Press the [EXPAND].



- Specify the setting value using the [▲] [▼] icon or the [⌂] icon.

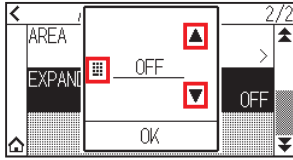

Supplement

- If the settings value is set to other than OFF (0.0 mm), transfer direction of the cutting area will also expand 5 mm forward.
- You can set the range between 1.0 mm and 10.0 mm, or OFF (0.0 mm).

- Confirm the setting and press the [OK].
- Press the [⌂] icon.
▶ It will return to HOME screen.

Setting length of the page

Set the length of one page when using roll media.

If the cut data is longer than the set page length, only the part that fits within the set page length will be cut, and the part that exceeds it will not be cut.

Supplement

- Default setting for page length is 2 m for CE8000-40, and 5 m for CE8000-60/130.
Check the setting of the page length when cutting long length.
* Please be sure to use the basket (option) when cutting something over 2 m for CE8000-60/CE8000-130.
- Page ejection quality assurance goes up to 2 m for the CE8000-40 and up to 5m for the CE8000-60/130.
(It depends on the media specified by Graphtec and setting conditions.)
 - Use the basket (option).
 - Use 3M Scotchcal Series 7725.
 - Set the speed below 30 and the acceleration below 2.
 - Perform pre feed for the amount to be used before cutting.
 - Leave the media in environment to use for adequate time if the deviation of temperature and humidity is big.
 - Set the both push rollers at least 15mm inside the edge of media.
- Set the sideway tension of the media uniform when setting the media when cutting long length.
Media might come off the rollers while cutting if it is not uniform.
- Pull out the amount to use before cutting when you are using the roll media.
- To reduce the shifting of the media, perform the pre feed to the full length to be cut.
(see "Pre Feed of Media (Paper or Marking Film)")
Also, pre feeding can be done automatically when the data is received.
(See "Perform Automatic Pre Feed When Cut Data is Received").
* Pre feeding will stabilize the feed by acclimating the media, taking out the slack.
- This setting will be saved even if the power is shut off.

Operation

- Press the [≡] icon.

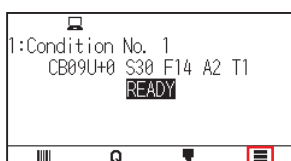

2. Press the [MEDIA].

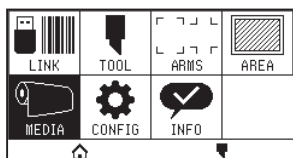

3. Press the [PAGE LENGTH].

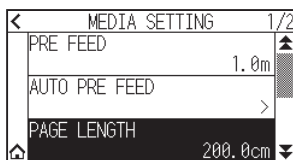

4. Specify the setting value using the [▲] [▼] icon or the [■] icon.

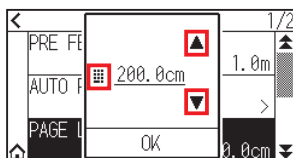

Supplement

You can set the range between 20.0 cm and 5000.0 cm.

5. Confirm the setting and press the [OK].
6. Press the [HOME] icon.
 - ▶ It will return to HOME screen.

Setting mirror

You can cut by reversing the cutting origin position and coordinate axes.

Supplement

This setting will be saved even if the power is shut off.

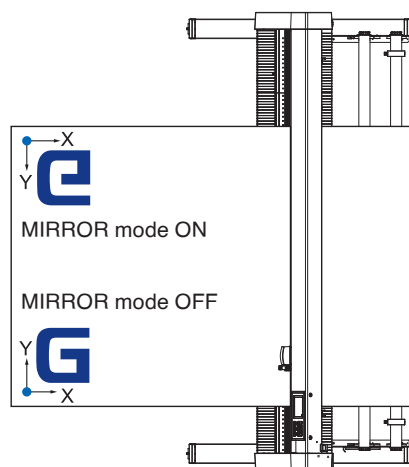

Operation

1. Press the [≡] icon.



2. Press the [AREA] key.

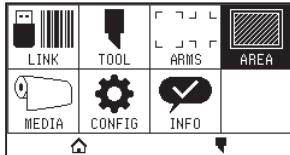

3. Press [MIRROR] to turn it to [ON].
To cancel, set it to [OFF].



4. Check the settings and press the [HOME] icon.
▶ It will return to HOME screen.

Set the enlarge/shrink scale (Scale)

It can enlarge or shrink cutting.

Supplement

This setting will be saved even if the power is shut off.

Operation

1. Press the [≡] icon.

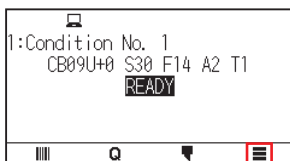

2. Press the [AREA] key.

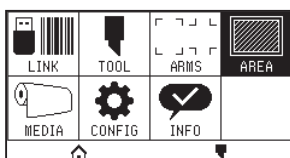

3. Press the [SCALE].

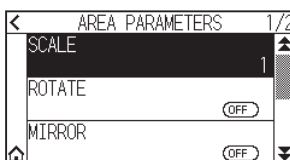

4. Display the scale to be used using the [▼] and [▲] icons.

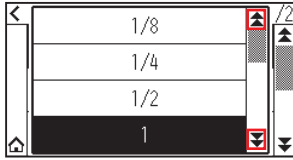

Supplement

Values that can be set are 1/8, 1/4, 1/2, 1, 2, 3, 4, 5, 6, 7 and 8.

5. Press the scale you want to use.
6. Press the [🏠] icon.
▶ It will return to HOME screen.

4.2 Copy (Duplicate Cutting)

Repeats cutting the specified number of times using the cutting data held in the buffer memory.

Supplement

- Do not send new data to plotter while copying. Cutting data in the buffer memory will be cleared.
- Previous cutting data will be cleared and newly sent data will be stored as cutting data if you send new data with 10 seconds or more interval from the time it finished cutting.
- It can not copy if data is more than 1.6 MB because it cannot be stored in the buffer memory of the plotter.
- Buffer memory that can be used for copy will decrease if you turn on the data sort.
Turn off the data sort when you need to copy cutting with large data.
See "8.1 Sorting the Cutting/Plotting Data" for data sort.
- If the original cutting data to be copied starts away from the origin point, copied cutting will also start away from the origin point.
To Avoid wasted space, create the cutting data close to the origin point.
- When copying using a roll paper barcode, be sure to scan the bar code on the leading edge.

When media change mode is OFF

Copy is performed in following order.

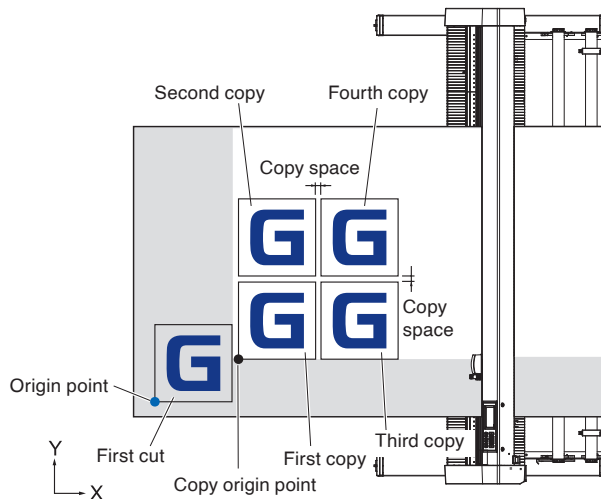

Copying when setting MIRROR is performed in the following order.

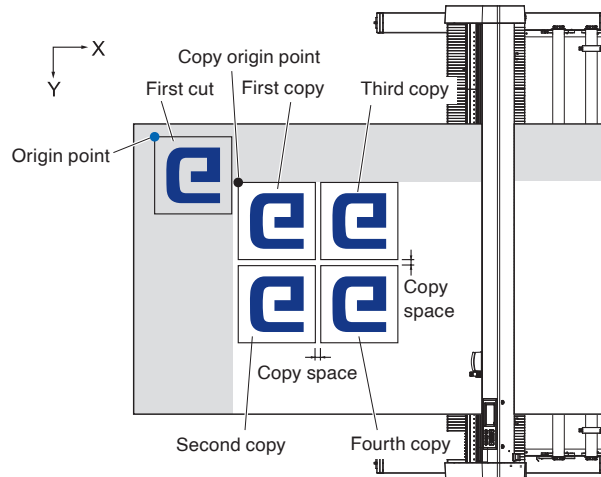

Copying when setting COORDINATE AXES ROTATION is performed in the following order.

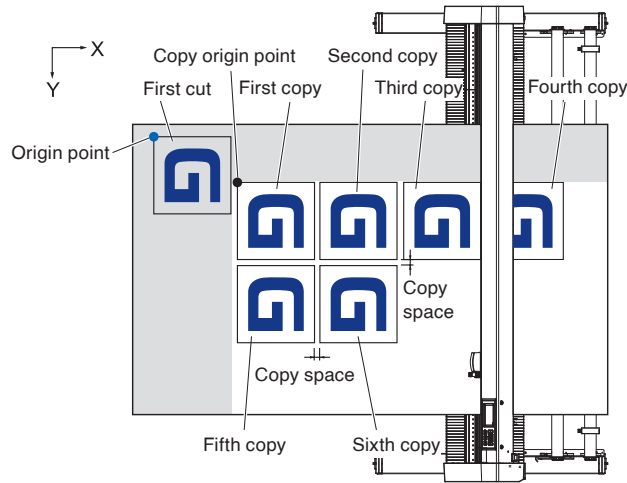

Operation

1. Plot (cut) the data you want to copy once.
▶ Cutting data is stored in the buffer memory.
2. Press the POSITION (▲, ▼, ◀, ▶) keys and move the tool carriage to the position to copy.
3. Press the [Q] icon.

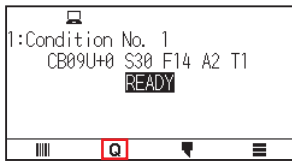

4. Press the [COPY].

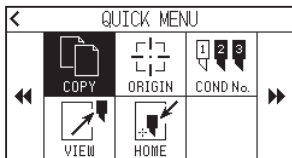

Supplement

- "NO DATA FOR COPY IN BUFFER!" is displayed if there is no data in the buffer memory.
- If too much data is sent from the buffer memory, "COPY MODE BUFFER FULL!" will be displayed.
- If the data to be copied is larger than the cutting area, "CANNOT COPY CUT AREA TOO SMALL!" will be displayed. Enlarge the cutting area or load a media that can secure a sufficient cutting area.

5. Press [MEDIA CHANGE MODE] to set to [OFF].

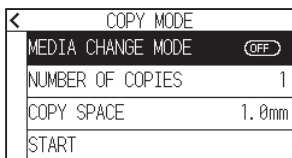

6. Press the [NUMBER OF COPIES].

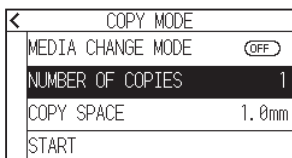

7. Specify the setting value using the [▲] [▼] icon or the [⏏] icon.

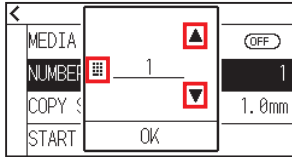

Supplement

- Number of copies can be set as much as it can fit in the media set on the printer.
- The initial value for the number of copies is always 1.

8. Confirm the setting and press the [OK].

9. Press the [COPY SPACE].

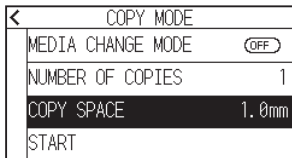

Supplement

Copy interval can be set when MEDIA CHANGE MODE is turned OFF.

10. Specify the setting value using the [▲] [▼] icon or the [⏏] icon.

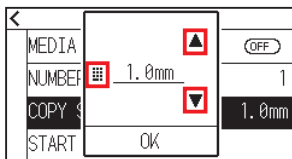

Supplement

- You can set the range between 1.0 mm and 10.0 mm.
- This setting is maintained even if the power is turned off.

11. Confirm the setting and press the [OK].

12. Press the [START].

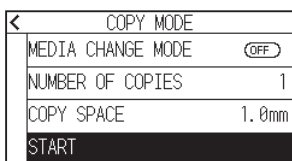

13. Press the [YES].

▶ The copy will start.

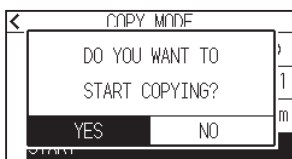

Supplement

- Cutting data is stored even if the media is exchanged.
- It can be copied as many times until the buffer memory is cleared.

When media change mode is ON

The Change Media message appears each time when ending a single cut in Media Change mode. Choosing to change media will instantly detect the media and proceed to a copy area.

Operation

1. Plot the data you want to copy once.
▶ Cutting data is stored in the buffer memory.
2. Press the [Q] icon.

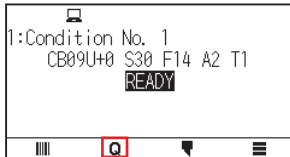

3. Press the [COPY].

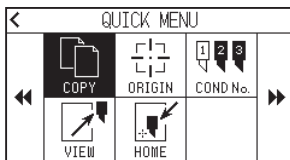

Supplement

- Turning MEDIA CHANGE MODE on will display the CHANGE MEDIA message each time after a single cut.

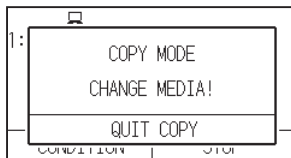

- If the [QUIT COPY] is pressed, copying will be suspended and it will return to the HOME screen.
- When exchanging media, the media selection will be chosen from what was selected before copying.
- If there is no data in the buffer memory, "NO DATA FOR COPY IN BUFFER!" will be displayed. Please send cutting data.
- If too much data is sent from the buffer memory, "COPY MODE BUFFER FULL!" will be displayed.
- If the data to be copied is larger than the cutting area, the message "CANNOT COPY CUT AREA TOO SMALL!" will be displayed. Please widen the cutting area or load a media that can secure a sufficient printing area.

4. Press the [MEDIA CHANGE MODE] to turn it to [ON].

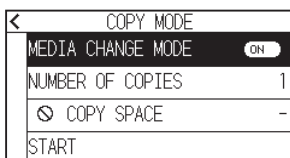

5. Press the [NUMBER OF COPIES].

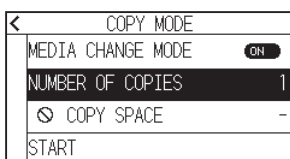

6. Specify the setting value using the [▲] [▼] icon or the [■] icon.

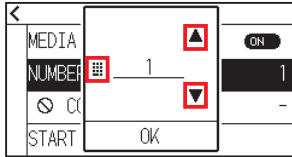

Supplement

You can set the range between 1 and 100.

7. Confirm the setting and press the [OK].

8. Press the [START].

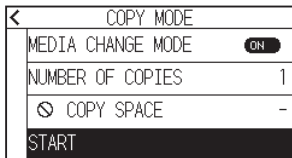

9. Press the [YES].

▶ The copy will start.

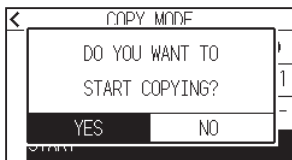

10. If the number of copies is 2 or more, replace the media after the first copy is completed.

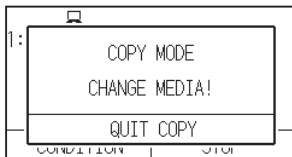

11. Press the [OK] or [ENTER] key after replacing the media.

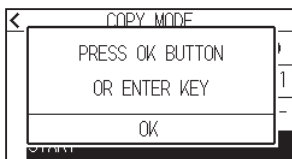

12. Start copying the second sheet.
Repeat this action the specified number of times.

Supplement

Cutting data is stored even if the media is exchanged.
It can be copied as many times until the buffer memory is cleared.

4.3 Panel Cutting

To prevent skew of long media, utilize Panel Cutting when cutting.

Supplement

- When Panel Cutting is on, the machine will begin by dividing up partition length and continue cutting until one of the following data breaks appears.
When the first partitioned area cut is finished, the machine will move to the next area, and repeat this until all areas have been cut.
- Data Breaks:
 - (1) No data sent for a few second after finishing cutting. (Time Out)
 - (2) A feed-related command is set. (GP-GL: F, FS commands, HP-GL: AF, AH, PG commands)
 - (3) HP-GL: SP0, NR, GP-GL: J0, SO.
 - (4) When commands from data breaks (2) and (3) appear, that command work will begin after the Panel Cutting is finished.
- Panel Cutting will continue for each piece of data when a data break is caused by a command, even if multiple pieces of data are sent in before the cutting finishes (even when numerous pieces of Panel Cutting data are in the plotter buffer).
- When Panel Cutting and auto media transfer are both turned on, the machine will ignore automatic media transfer length settings and continue working with priority of partition length plus something minutes ago (with footprints).
- When Panel Cutting is on, and registration marks will not be seen ignored, and copy, initial feed, and cutting area cannot be changed.
- Panel Cutting cannot be done when one file of data makes the buffer full. Make sure to always send in data lower than the buffer size.
- This setting will be saved even if the power is shut off.

Operation

1. Press the [≡] icon.

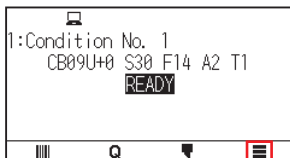

2. Press the [MEDIA].

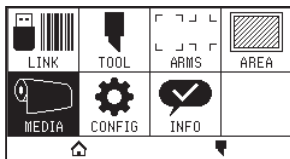

3. Press the [▼] icon.

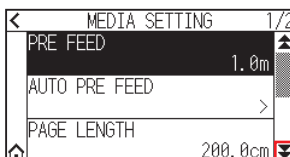

4. Press the [PANEL CUTTING].

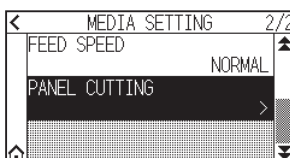

5. Press [ENABLE FUNCTION] to turn it to [ON].

▶ To cancel, set it to [OFF].

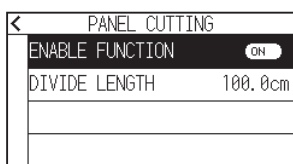

6. Press the [DIVIDE LENGTH].

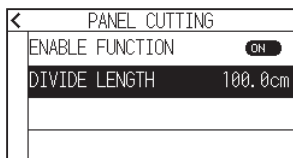

7. Specify the setting value using the [▲] [▼] icon or the [■] icon.

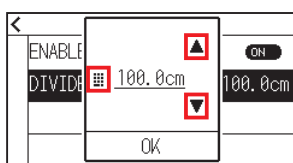

Supplement

You can set the range between 1.0 cm and 2000.0 cm.

8. Confirm the setting and press the [OK].

9. Press the [◀] icon.

10. Press the [🏠] icon.

▶ It will return to HOME screen.

Chapter 5: ARMS ***(Advanced Registration Mark Sensing System)***

This chapter describes the outline of the ARMS (Advanced Registration Mark Sensing System) and how to setup and use the ARMS.

SECTION IN THIS CHAPTER

5.1 Outline of ARMS

5.2 Setting and Adjustment of ARMS

5.1 *Outline of ARMS*

ARMS (Advanced Registration Mark Sensing System) is a function to scan the registration mark plotted on the media using sensors.

With ARMS, tilt of the axes and distance can be adjusted with 2 POINTS or 3 POINTS. 2 axes warp adjustment can be adjusted in addition to axes adjustment (tilt) and distance adjustment with 4 POINTS.

When cutting the outlines of the printed figure, and when re-cutting media, using ARMS to adjust for printing position discrepancies, high precision cutting/plotting can be done.

It is possible to perform a multiple registration mark adjustment or segment area adjustment by linking with the application software on the computer. See the operation guides of the application software about the registration mark adjustment function linked with the application software.

Registration mark scanning accuracy when a designated registration mark is being scanned by this machine is within 0.3 mm.

Please take note of the following when scanning a registration mark.

- Shape (Pattern) of the Registration Mark and Origin Point
- Scan Range Necessary to Detect the Registration Mark
- Positioning of the Media and the Registration Mark
- Cutting area when adjusting the registration mark
- Automatic detection of registration mark position
- Media That Registration Mark Cannot be Detected

Shape (Pattern) of the Registration Mark and Origin Point

The shapes (patterns) of the registration mark the plotter can scan are following 4 types.

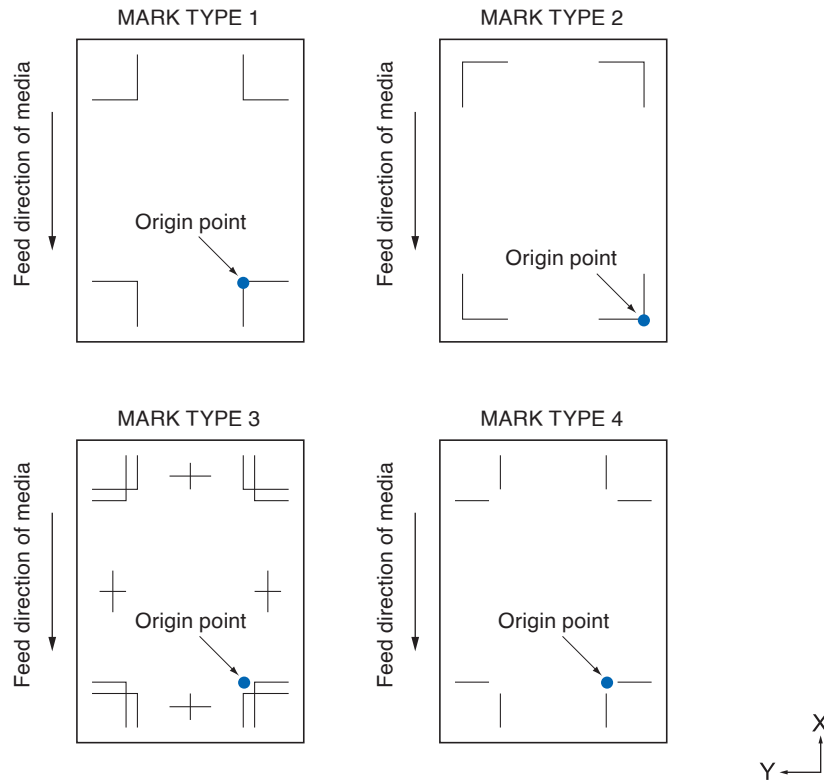

Supplement

- Create the registration mark as a plotting data with the application software. Registration mark pattern 3 and 4 should be created using Adobe Illustrator.
- Create the registration mark in accordance with following conditions.
 - Thickness of the line is between 0.3 to 1.0 mm.
 - Size of the registration mark is between 5 to 20 mm (see "Setting Registration Mark Size").
 - Use pattern 1, pattern 2, pattern 3 or pattern 4 for the shape of the registration mark.
 - Create the registration mark with single line, and specify the thickness of line to necessary thickness. Double line cannot be used.
- Panel Cutting should be switched to OFF.

Scan Range Necessary to Detect the Registration Mark

The range of tool carriage and media movement needed to scan the registration mark is as following.
Do not print in the shaded area shown in the Figure below.

<For 3 POINTS>

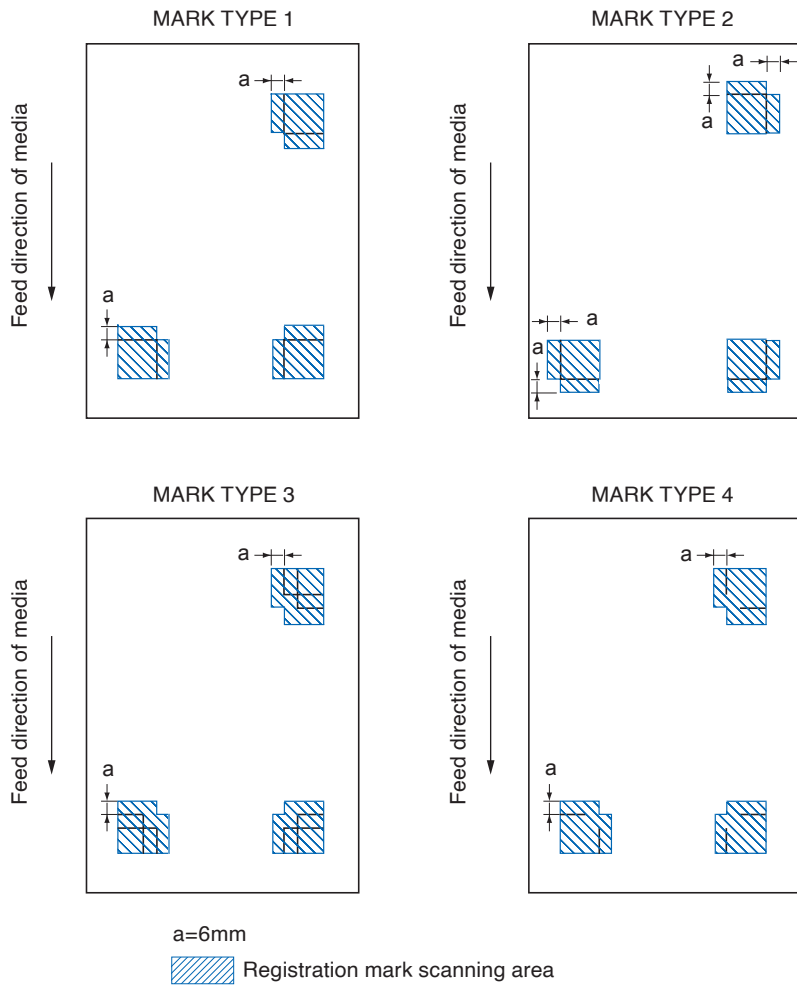

<For 4 POINTS>

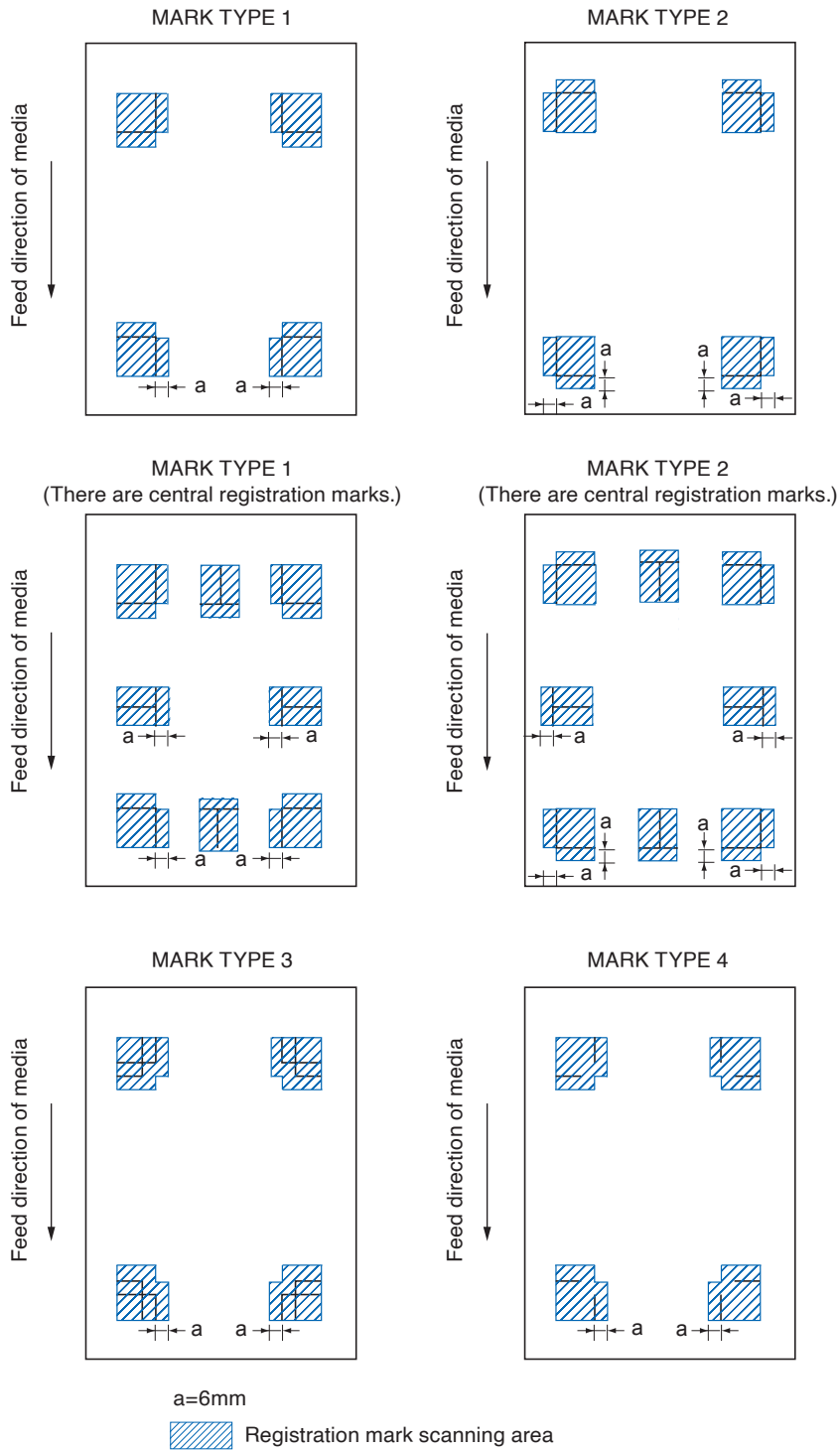

Supplement

- Clean any dirt or foreign objects from the media. Any dirt or foreign object might be scanned mistakenly as registration mark.
- Plot the registration mark in contrast easy to scan, such as black lines on white background.
Set the automatic detection of registration mark position to OFF if you need to use the colored or glossy media. (See "Set the registration mark automatic detection")

Positioning of the Media and the Registration Mark

Place the registration mark away from the edge of media to scan the registration mark.
 Make sure the push roller location is outside of the registration mark.
 Draw the registration mark as shown in the next image.

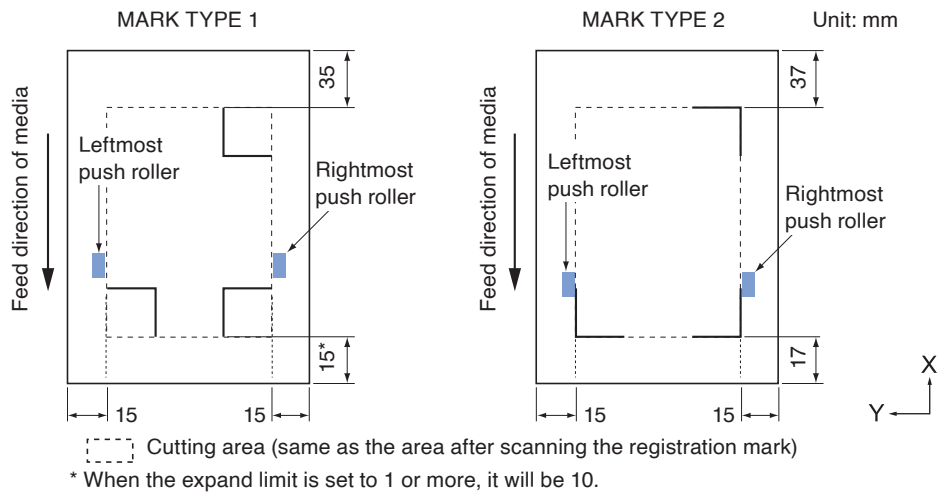

Cutting area when adjusting the registration mark

Even when the registration marks are being adjusted, you can cut the outside of the registration mark (cutting area).

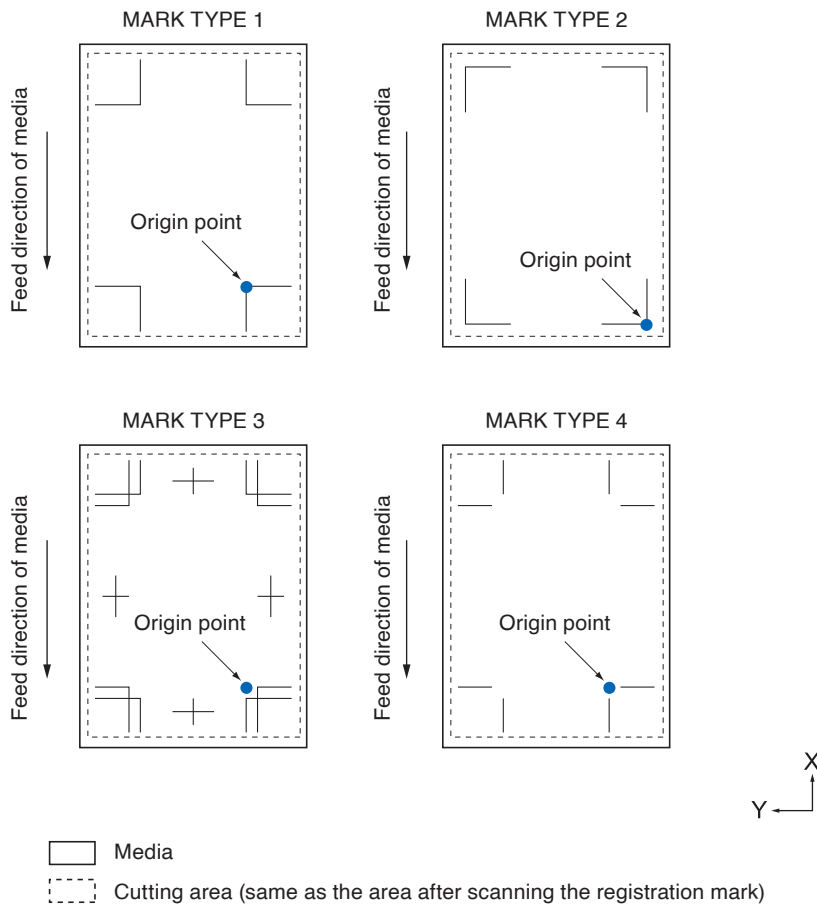

Automatic detection of registration mark position

The registration mark is detected within area A from the registration mark scanning start position (tool position). When the registration mark is not detected within the area A, then within area B is detected. Only when the registration mark is present in area A or B, it is possible to recognize as the mark.

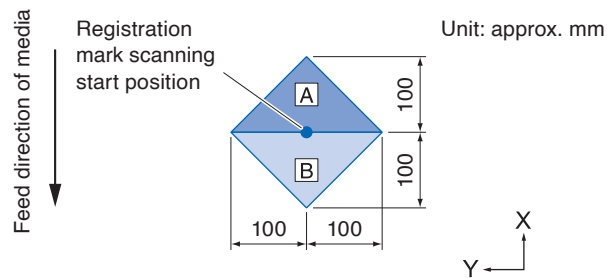

Media That Registration Mark Cannot be Detected

It may be hard to scan the registration mark as following, depending on the media conditions.

- Transparent media
- Lines of registration marks are blurred
- Media that does not become an expected color due to the color of the background after printing
- Folded media
- Surface is dirty
- Laminated media (Depending on the type and condition of the laminate)

If you use media that does not have registration marks printed in black on white background, set the automatic detection of registration mark position to OFF. (See "Set the registration mark automatic detection")

5.2 Setting and Adjustment of ARMS

This section describes the necessary adjustment and settings to correctly scan the registration mark with ARMS.

- Automatically adjust the registration mark sensor level
- Manually adjust the registration mark sensor level
- Test the registration mark sensor
- Adjust for the registration mark scan position
- Set the registration mark automatic detection
- Set speed of the registration mark scan

Automatically adjust the registration mark sensor level

Automatically adjusts the sensor level that scans the registration marks (threshold value for distinguishing between the background color of the media and the registration mark line).

The sensor is adjusted to scan the registration mark plotted with a black line on a white background. Readjust the sensor scanning level depending on the color and gloss of the media.

If automatic adjustment is difficult due to the surface properties of the media, manually set the sensor scanning level.

Operation

1. Print a standard registration mark pattern (MARK TYPE).
(Either MARK TYPE 1 or MARK TYPE 2 can be used.)

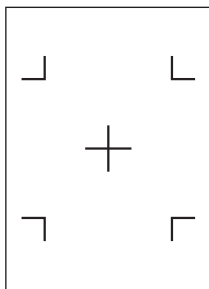

MARK TYPE 1

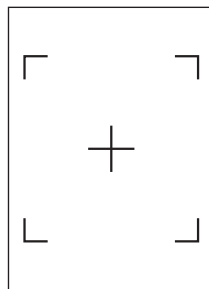

MARK TYPE 2

Supplement

- For the level adjustment pattern, use the one with the registration mark color and registration mark line width plotted on the media to be used.
- Please download standard registration mark patterns from our website.

Registration Mark Pattern	File Format	File Name
MARK TYPE 1	pdf	ARMStest_type1.pdf
	eps	ARMStest_type1.eps
MARK TYPE 2	pdf	ARMStest_type2.pdf
	eps	ARMStest_type2.eps

2. Load the printed media on the plotter.
3. Press the [≡] icon.

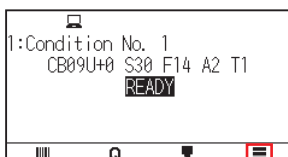

4. Press the [ARMS].

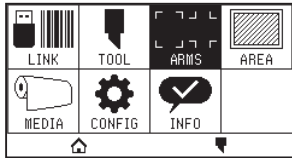

5. Press the [SENSOR ADJUSTMENT].

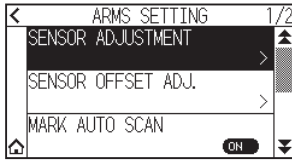

6. Press the [SENSOR ADJUST].

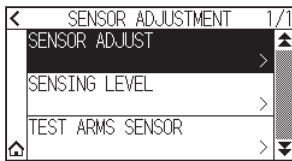

7. Press the [SCAN].

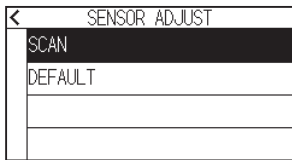

Supplement

Press the [DEFAULT] to set the sensor level to the initial value.

8. Press the POSITION (▲, ▼, ◀, ▶) keys to move the tool to the scanning start position.

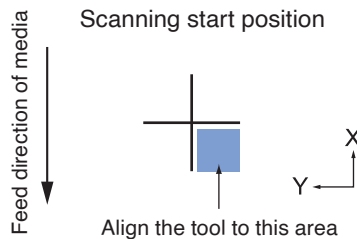
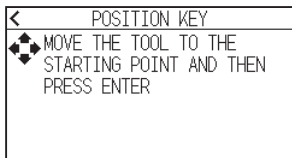

9. Confirm the position of the tool and press the [ENTER] key.
 ▶ The cross will be scanned and the scanning level will be adjusted.

Supplement

- If the cross cannot be scanned, an error message will be displayed.

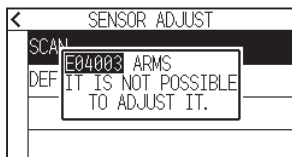

- Depending on the condition of the media, it may not be possible to scan it properly even after adjustment. If the detection operation does not complete normally, please See "6.2 Manual Position Adjust".

10. Press the [◀] icon.

11. Press the [🏠] icon.

▶ It will return to HOME screen.

Manually adjust the registration mark sensor level

Manually set the level of the sensor that scan the registration marks (threshold value that distinguishes between the background color of the media and the registration mark line).

The sensor is adjusted to scan the registration mark plotted with a black line on a white background. Adjust the sensor scanning level depending on the color and gloss of the media.

Operation

1. Press the [≡] icon.

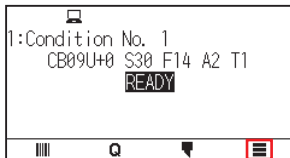

2. Press the [ARMS].

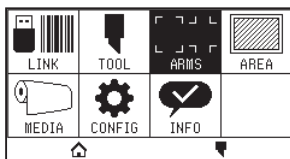

3. Press the [SENSOR ADJUSTMENT].

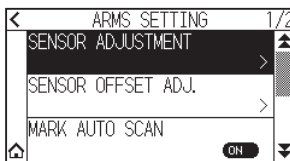

4. Press the [SENSING LEVEL].

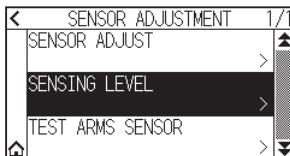

Supplement

- For the sensing level, specify what percentage of the signal level difference between the background color of the media and the registration mark is to be set as the threshold.
- Set the level for sensing registration mark while moving in the X direction (feed direction of media) for X, and the sensing level for sensing registration mark while moving in the Y direction (tool carriage movement direction) for Y.
- In the following cases, register marks may be scanned by increasing the value.
 - When the color of the media and the color of the register mark are similar.
 - When the registration mark passes past the position.
- In the following cases, register marks may be scanned by decreasing the value.
 - When a position with no registration mark is scanned.
 - When folds or dirt on the media surface is scanned.

5. Press the [X].

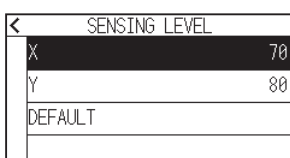

6. Specify the setting value using the [▲] [▼] icon or the [⌂] icon.

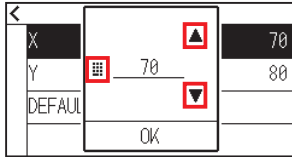

Supplement

You can set the range between 30 and 90.

7. Confirm the setting and press the [OK].

8. Press the [Y].

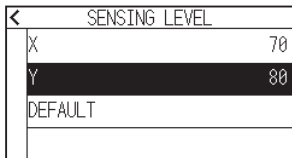

9. Specify the setting value using the [▲] [▼] icon or the [⌂] icon.

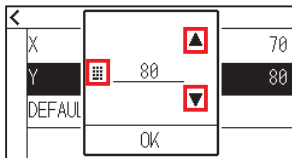

Supplement

You can set the range between 30 and 90.

10. Confirm the setting and press the [OK].

11. Press the [<] icon.

12. Press the [⌂] icon.

▶ It will return to HOME screen.

Test the registration mark sensor

If there still is a difference in the cutting/plotting, even after performing an adjustment using the registration mark, it is possible to check if there is a problem with the registration mark itself or the application by checking the position of the registration mark plotted.

Operation

1. Print the standard registration mark.
(Either MARK TYPE 1 or MARK TYPE 2 can be used.)

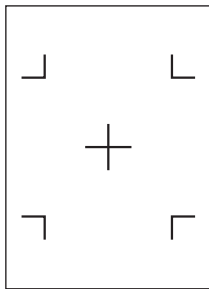

MARK TYPE 1

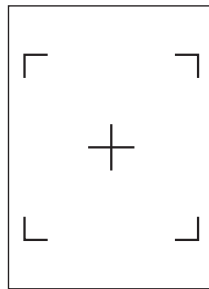

MARK TYPE 2

Supplement

- If you want to test the MARK SCAN MODE 1, print "Test Pattern 1", and if you want to test the MARK SCAN MODE 2, print "Test Pattern 2".
- Please download standard registration mark patterns from our website.

Registration Mark Pattern	File Format	File Name
MARK TYPE 1	pdf	ARMStest_type1.pdf
	eps	ARMStest_type1.eps
MARK TYPE 2	pdf	ARMStest_type2.pdf
	eps	ARMStest_type2.eps

2. Load the printed media on the plotter.
3. Press the [≡] icon.

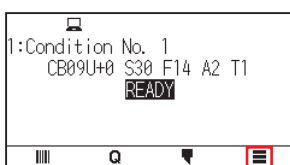

4. Press the [ARMS].

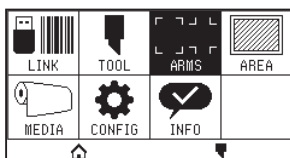

5. Press the [SENSOR ADJUSTMENT].

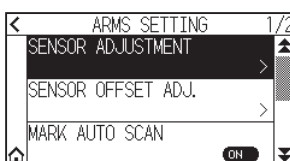

6. Press the [TEST ARMS SENSOR].

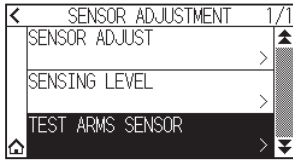

7. Press the type of registration mark you want to use.

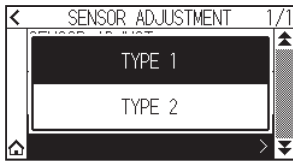

8. Press the POSITION (▲, ▼, ◀, ▶) key to move the tool to the registration mark scanning start area.

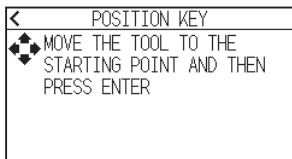

Registration mark scanning start area

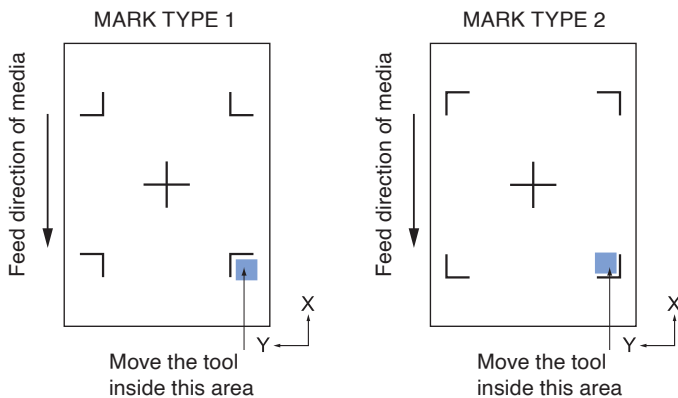

9. Confirm the position of the tool and press the [ENTER] key.
 ► The plotter will automatically detect the registration mark and cut the cross.

CAUTION

With this function, cutting is performed after sensing the register mark pattern.
 If you use a cutter as a tool, be careful not to damage the plotter.

Supplement

Following error is displayed when the registration mark was not scanned properly.
 Press the [RETRY] to scan again, or the [CANCEL] to exit.

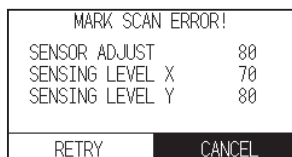

10. Confirm the cutting result.
 ► See "Adjust for the registration mark scan position" and adjust if the cutting position is shifted.
 See "Automatically adjust the registration mark sensor level" above and make adjustments if you are unable to scan the registration marks.

Adjust for the registration mark scan position

Sensor to scan the registration mark is positioned away from the tip of the tool. Therefore, it is necessary to adjust the coordinate values of the scanned registration mark so it will match with the plotting position.

If the registration mark is already marked on the media, scan that registration mark, plot another registration mark in the same position, and measure the difference between them. This difference is entered as an adjustment value.

If there is no registration mark on the media, plot a registration mark first, scan that registration mark, plot another registration mark, and measure the difference of them. This difference is entered as an adjustment value.

When using media and tools for actual use, the adjustment accuracy will be higher.

Adjust after plotting the correction registration mark

This section describes the procedure to adjust the registration mark scan position if there is no registration mark on the media.

Supplement

See “Adjust using plotted adjustment registration mark” if there is registration mark on the media.

Operation

1. Load white media into the plotter.
2. Set the water-based fiber pen (black) on the backward of tool holder.

Supplement

- Check If the Water-based fiber-tip pen has been scratched.
- Water-based fiber pen is an optional item.

3. Press the [≡] icon.

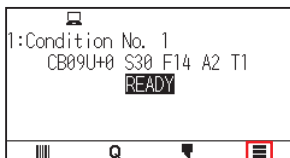

4. Press the [ARMS].

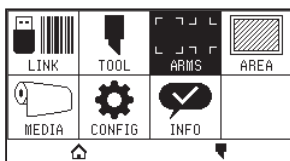

5. Press the [SENSOR OFFSET ADJ.].

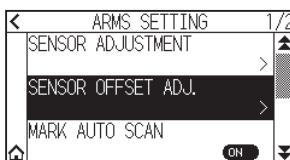

6. Press the [DRAW].

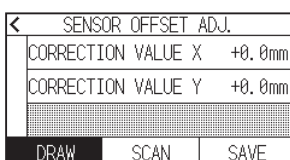

7. Press the POSITION (▲, ▼, ◀, ▶) keys and move the tool to the position to create the registration mark (position nothing is printed)

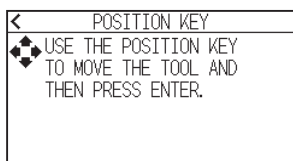

8. Press the [ENTER] key.
▶ An adjustment registration mark is created, and then it will return to the SENSOR OFFSET ADJ. screen.
9. Press the [SCAN].

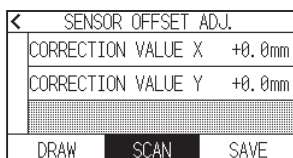

10. Press the POSITION (▲, ▼, ◀, ▶) keys to move the tool to the scanning start position.

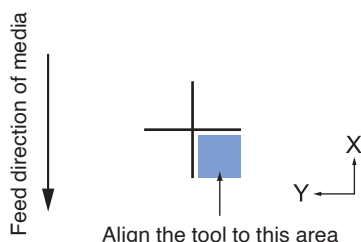
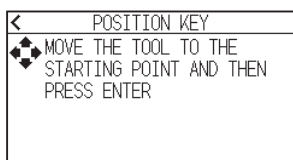

11. Check the position of the tool and press the [ENTER] key.
▶ After scanning the registration marks, plot the registration marks for comparison. When plotting is completed, it will return to the SENSOR OFFSET ADJ. screen.

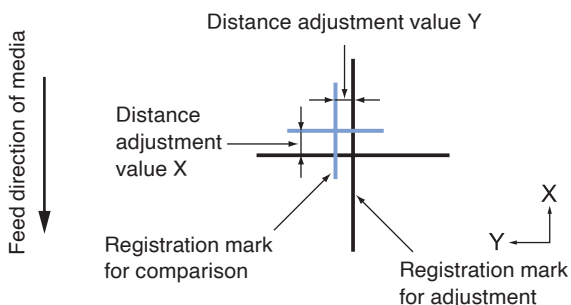

12. Using the registration mark plotted in step 8, measure the distance of how much the adjustment registration mark needs to be moved so both will overlap, and record the value. As an example, in the figure in step 11, it needs to move in negative directions for both X and Y directions, so both of the adjustment values will be negative values.

Supplement

Position of the registration mark is measured at the center of the line.

13. Press the [CORRECTION VALUE X].

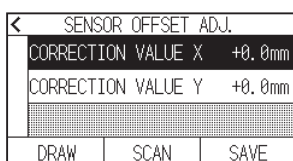

14. Specify the setting value using the [▲] [▼] icon or the [■] icon.
Enter the value of X measured in step 12.

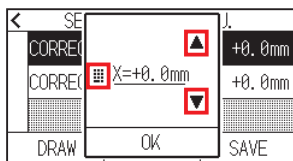

Supplement

You can set the range between -3.0 mm and +3.0 mm.

15. Confirm the setting and press the [OK].
16. Press the [CORRECTION VALUE Y].

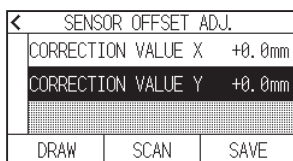

17. Specify the setting value using the [▲] [▼] icon or the [■] icon.
Enter the value of Y measured in step 12.

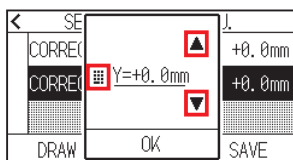

Supplement

You can set the range between -3.0 mm and +3.0 mm.

18. Confirm the setting and press the [OK].
19. Press the [SAVE].
20. Press the [HOME] icon.
▶ It will return to HOME screen.

Adjust using plotted adjustment registration mark

This section explains the procedure when the registration marks required to adjust the registration mark scanning position is already plotted on the media.

Supplement

See “Adjust after plotting the correction registration mark” if there is no registration mark.

Operation

1. Load the media with registration marks for adjustment.
2. Press the [■] icon.

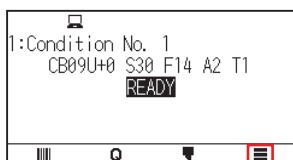

3. Press the [ARMS].

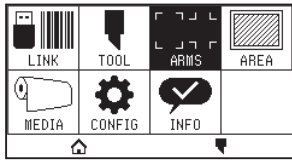

4. Press the [SENSOR OFFSET ADJ.].

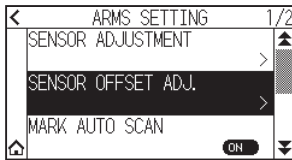

5. Press the [SCAN].

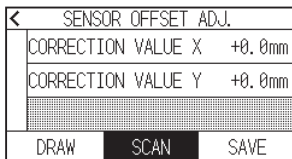

6. Press the POSITION (▲, ▼, ◀, ▶) keys to move the tool to the scanning start position.

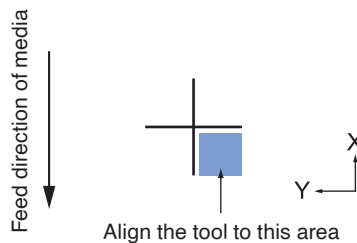
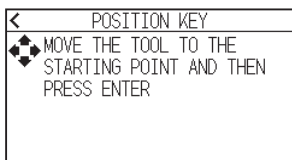

7. Check the position of the tool and press the [ENTER] key.

▶ After scanning the registration marks, plot the registration marks for comparison. When plotting is completed, it will return to the SENSOR OFFSET ADJ. screen.

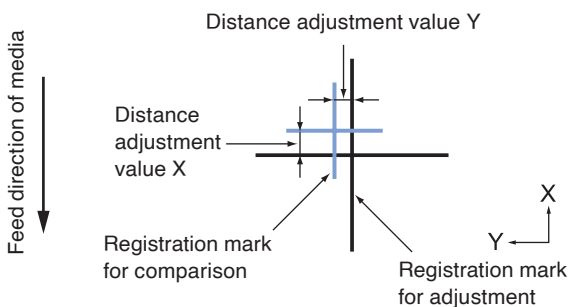

8. Based on the scanned registration mark for adjustment, measure the distance of how much the adjustment registration mark needs to be moved so both will overlap, and record the value. As an example, in the figure in step 7, it needs to move in negative directions for both X and Y directions, so both of the adjustment values will be negative values.

Supplement

Position of the registration mark is measured at the center of the line.

9. Press the [CORRECTION VALUE X].

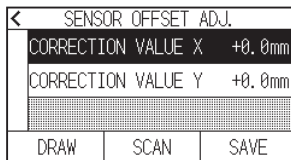

10. Specify the setting value using the [▲] [▼] icon or the [■] icon.
Enter the value of X measured in step 7.

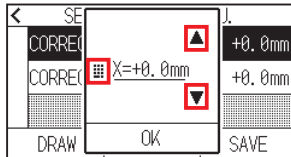

Supplement

You can set the range between -3.0 mm and +3.0 mm.

11. Confirm the setting and press the [OK].
12. Press the [CORRECTION VALUE Y].

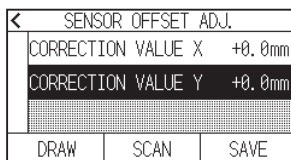

13. Specify the setting value using the [▲] [▼] icon or the [■] icon.
Enter the value of Y measured in step 7.

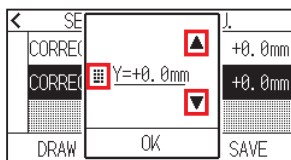

Supplement

You can set the range between -3.0 mm and +3.0 mm.

14. Confirm the setting and press the [OK].
15. Press the [SAVE].
16. Press the [HOME] icon.
▶ It will return to HOME screen.

Set the registration mark automatic detection

When setting the registration mark automatic detection to on, if the current position of the tool is close to the position of the first registration mark (Point 1) at the time of registration mark automatic detection, the registration mark is automatically scanned without moving to the scanning start position of tool. If set to OFF, this operation will not be performed.

Supplement

If the current position of the tool is distanced from the first registration mark, detection may take a long time, and errors due to not finding anything may occur.

Operation

1. Press the [≡] icon

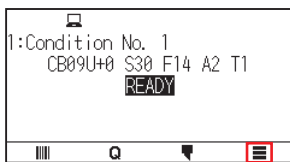

2. Press the [ARMS].

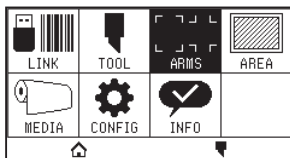

3. Press [MARK AUTO SCAN] to turn it to [ON].
To cancel, set it to [OFF].

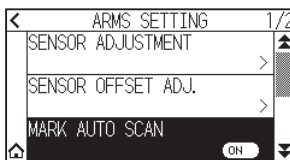

4. Press the [HOME] icon.
▶ It will return to HOME screen.

Set speed of the registration mark scan

Speed of the tool carriage and media to scan the registration mark is set.

It may not scan the registration marks or the difference may become large when the speed is too high, but the scanning time becomes longer when the speed is too slow. Adjust the setting value considering the balance. If the registration mark cannot be scanned or the error is large, setting a low (slower) value may improve the scanning.

Operation

1. Press the [≡] icon.

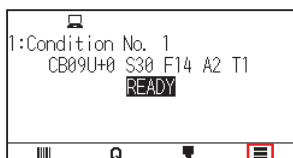

2. Press the [ARMS].

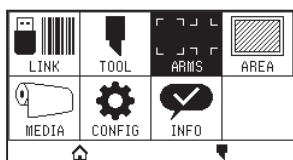

3. Press the [▼] icon.

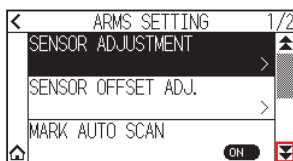

4. Press the [SENSING SPEED].

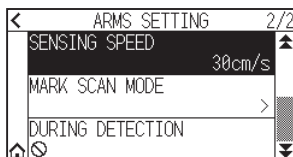

5. Specify the setting value using the [▲] [▼] icon or the [⌘] icon.

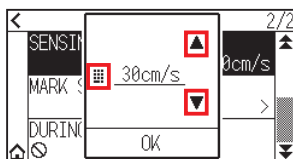

Supplement

You can set the range between 1 cm/s and 30 cm/s.

6. Confirm the setting and press the [OK].
7. Press the [HOME] icon.
▶ It will return to HOME screen.

Chapter 6: Manual Position Adjust

This chapter describes how to manually align media and tool positions.

SECTION IN THIS CHAPTER

6.1 Outline of Manual Position Adjust

6.2 Manual Position Adjust

6.1 Outline of Manual Position Adjust

With manual position adjust, tilt of the axes are adjusted using the 2 POINTS, 3 POINTS, or 4 POINTS adjustment marks (grits or registration marks) as a standard. The distance between each point can also be entered to adjust the distance.

Move the tip of each tool to the appropriate point.

Use the media with prints (grits or registration marks) necessary to get XY axes and origin point.

Supplement

If you want to perform accurately matching up points, please use the ARMS function.

Setting mark scan mode and number of adjustment marks

To perform the AXIS ALIGNMENT, set the MARK SCAN MODE to "AXIS ALIGNMENT".

Select the number of the registration marks (adjustment marks) from 2 POINTS, 3 POINTS, or 4 POINTS when the MARK SCAN MODE is set to "AXIS ALIGNMENT". Position of each adjustment marks are as following.

Adjust with 2 POINTS

2 POINTS adjustment will scan 2 registration marks aligned in the media transportation direction, where the adjustment is done measuring the tilting of the axis and the distance between the registration marks. This adjustment is 1-axis adjustment (tilt adjustment).

If the loaded media is tilted as shown below, position of the scanned registration mark is shifted from the position where it should be. Tilt and distance can be adjusted by comparing these coordinate values.

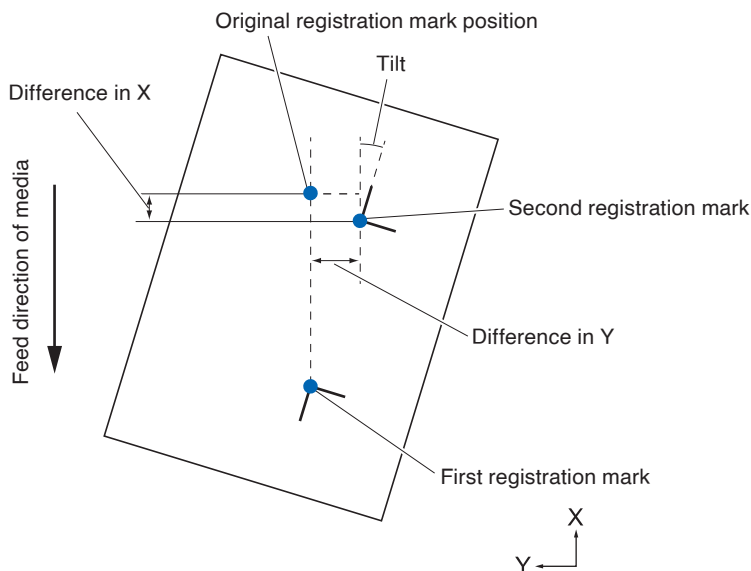

Adjust with 3 POINTS

3 POINTS adjustment will scan 3 registration marks as shown below, where the adjustment is done measuring the tilting of the X and Y axes and the distance between the registration marks (horizontal and vertical directions). This adjustment is called 2-axis adjustment (tilt adjustment).

If the loaded media is tilted as shown below, position of the scanned registration mark is shifted from the position where it should be. Tilt and distance can be adjusted by comparing these coordinate values.

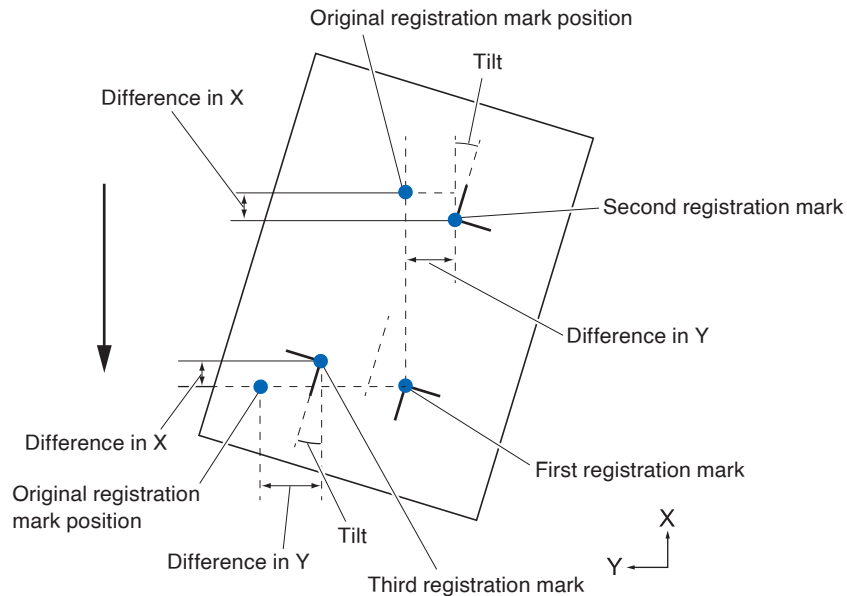

Adjust with 4 POINTS

4 POINTS adjustment will scan 4 registration marks in the corners, where the adjustment is done measuring the tilting of the X and Y axes and the distance between each of the registration marks. It will perform 2 axes warp adjustment in addition to the 2 axes (tilt) adjustment and distance adjustment, so it can adjust more precisely than other methods.

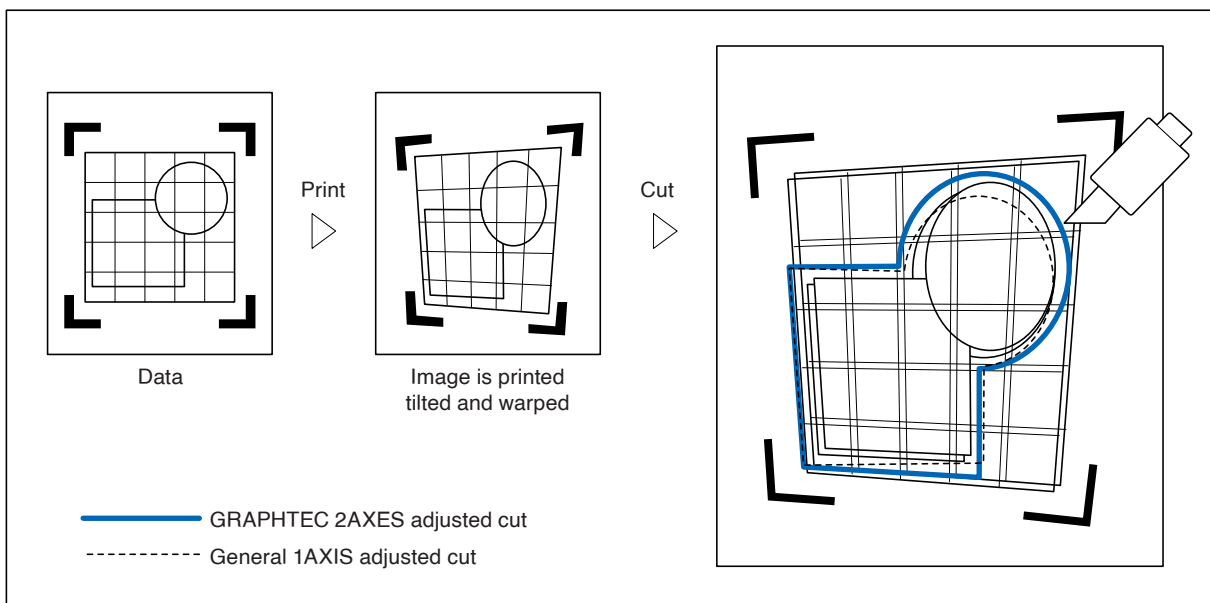

6.2 Manual Position Adjust

Method of manual position adjust is described here.

Supplement

- Adjustment will be cleared if following is done.
 - Set new origin point.
 - Set the media again.
 - Set rotation or mirror. (Set the rotation or mirror prior to the axis adjustment)
 Axis adjustment will convert in accordance with rotation or mirror in this case.
- When the inclination of the axis is too large when setting the first and second point, the first and third point, the third and fourth point, or the second and fourth point, "Angle adjustment error, please reset" will be displayed. After setting the media so as to make the inclination small, please perform adjustment operations.
- Axis adjustment will be cleared when point 1 and point 2 is set to same point.

Operation

1. Load the media on which the registration mark patterns are printed.

Supplement

Confirm that the push roller is steadily on the media within the range of media movement.
This adjustment is based on assumption that media is slightly tilted.
Media might fall off if the tilting of the media is too large.

2. Set a cutter plunger or a pen in the tool holder.
3. Press the [≡] icon.



4. Press the [ARMS].

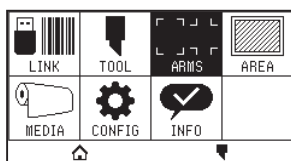

5. Press the [▼] icon.

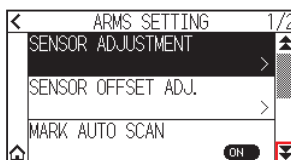

6. Press the [MARK SCAN MODE].

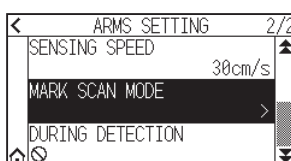

7. Press the [MARK SCAN MODE].

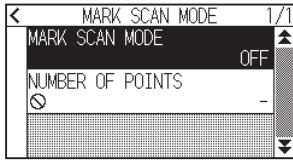

8. Press the [AXIS ALIGNMENT].



9. Press the [NUMBER OF POINTS].

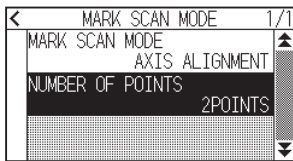

10. Press the number of points you want to use.

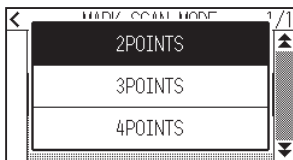

Supplement

Please refer to the following for adjustments when matching the manual position.

- 2 points matching, ["Point 1" settings] ["Point 2" settings] ["Origin point of the axis adjustment" settings] [Finish]
- 3 points matching, ["Point 1" settings] ["Point 2" settings] ["Point 3" settings] ["Distance between Point 1-2" settings] ["Distance between Point 1-3" settings] ["Origin point of the axis adjustment" settings] [Finish]
- 4 points matching, ["Point 1" settings] ["Point 2" settings] ["Point 3" settings] ["Point 4" settings] ["Distance between point 1-2" settings] ["Distance between point 1-3" settings] [Finish]

11. Press the [◀] icon.

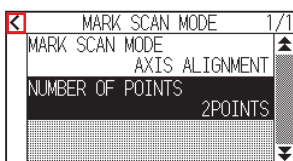

12. Press the [DURING DETECTION].

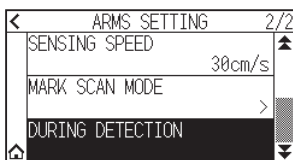

13. Press the POSITION (, , , ) key to move it to the adjustment mark position.

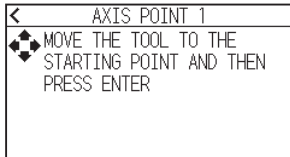

Supplement 

Pressing the POSITION and [SLOW] keys at the same time will move the tool carriage slower.

14. Confirm the position of the tool and press the [ENTER] key.
- ▶ Set adjustment points 2 to 4 in the same way. (The number of adjustment points varies depending on the [NUMBER OF POINTS] setting.)
 - ▶ When the adjustment point specification is completed, the DISTANCE screen will be displayed.

15. Press the number or the  icon.

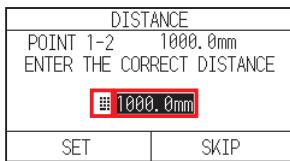

Supplement 

- Measured distance is displayed in the top line in the DISTANCE input screen. Input value (initially same as measured value) is displayed under that.
- If the input value is not changed, it will assume that there is no difference between measured distance and the distance in the data.

16. Specify the setting value using the   icon or the  icon.

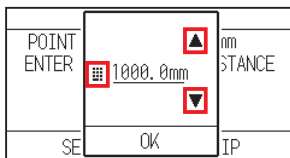

17. Confirm the setting and press the [OK].

18. Press the [SET].

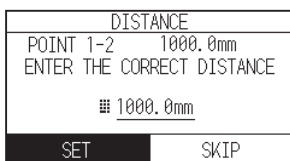

Supplement 

If [NUMBER OF POINTS] is set to 3 or more points, the DISTANCE screen for points 1-3 will be displayed. Repeat steps 15 to 17 to set the settings.

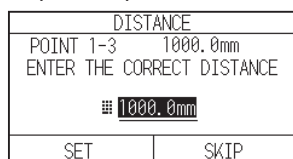

19. Press the POSITION (▲, ▼, ◀, ▶) keys and move the tool carriage to the origin point.

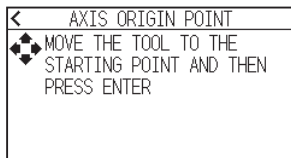

Supplement 

This is displayed only when [NUMBER OF POINTS] is set to 2 POINTS or 3 POINTS.

20. Confirm the tool position and press the [ENTER] key.

21. Press the [] icon.

▶ It will return to HOME screen.

Chapter 7:

Settings Regarding Cutting Quality

There are times that ideal cutting may not be possible, such as the lines may shift, corners deform, or uncut sections occur, due to the characteristics of the media (thickness, how hard it is, etc.) or the shape of the blades, when the actual cutting is done. Adjust the moving speed and force of the tool, and the control method to prevent these problems.

This chapter describes the setting regarding the quality of the cutting.

SECTION IN THIS CHAPTER

- 7.1 Cutting the Corner of Thick Media Sharp*
- 7.2 Setting the Step Pass*
- 7.3 Setting the Offset Angle*
- 7.4 Setting the Distance Adjust*
- 7.5 Setting Cut Line Pattern*
- 7.6 Setting Initial Blade Control Position Adjust*
- 7.7 Setting the blade control force*
- 7.8 Setting Adjustment Between the Tools*

7.1 Cutting the Corner of Thick Media Sharp

Outline of tangential mode

The blade needs to be facing toward the direction of cut when cutting the media. The tip of the blade is shaped as shown so the blade is facing the cutting direction even when it is cutting curved lines or corners. The tip of the blade is off from the rotation axis of the blade (CUTTER OFFSET). The blade will automatically turn and face the cutting direction when the tool carriage moves, because the blade is forced to move from the rotation center, and the blade tip gets resistance by the media.

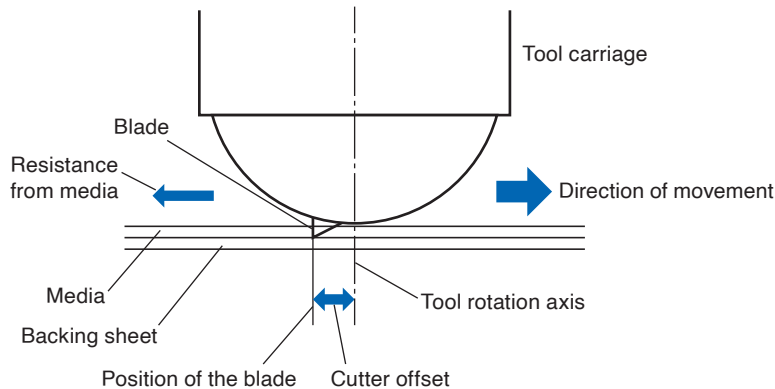

The blade tip gets sunk into the media with 0.3 mm or thicker, making the blade hard to rotate. Especially for the corners where two straight lines meet, cutting becomes very hard because it cannot rotate smoothly. Tangential mode is a control method to precisely cut corners where two straight lines meet. With the tangential mode, the blade is advanced so it will overcut at the corners before raising the tool. Then, it will be lowered at the position slightly before the next line, and start to cut with slight overcut.

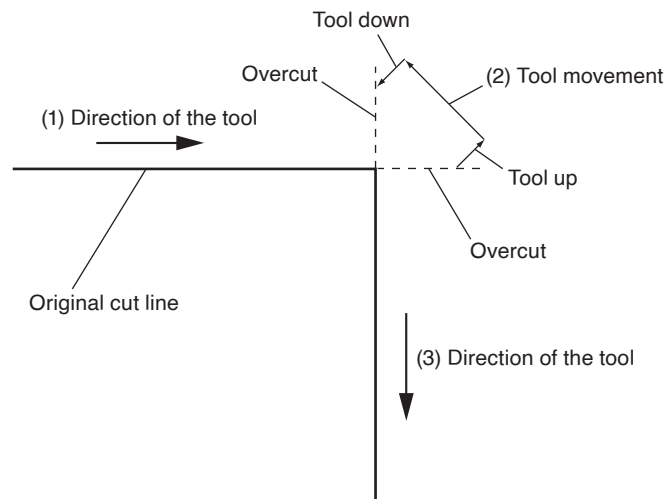

There are 2 modes for tangential mode.

- Mode 1:** Overcuts the start and end points and acute-angle corners to eliminate uncut sections. In addition, the cutter blade is moved on the surface of the medium during cutting when it is rotated significantly, ensuring sharp cutting unaffected by the hardness or thickness of the media.
- Mode 2:** Overcuts the start and end points only. In addition, the cutter blade is rotated on the medium surface for the start cutting position only. Mode 2 uses simpler cutter control than Mode 1, and provides a shorter cutting time.

The length of the overcuts by tangential mode can be set individually for start of the line and for end of the line.

Setting the tangential mode

Enabled (Mode 1 and Mode 2) and OFF of the tangential mode can be set individually for each of tool condition No. 1 to 8.

Operation

1. Press the [▼] icon.



2. Press the [EDIT CUT CONDITION].

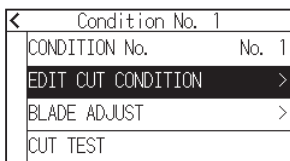

3. Press the [▼] icon four times.

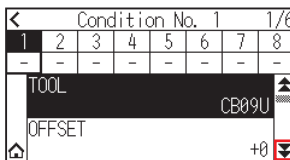

4. Press the tool condition number (1 to 8) you want to set.

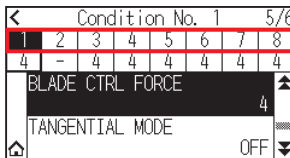

5. Press the [TANGENTIAL MODE].

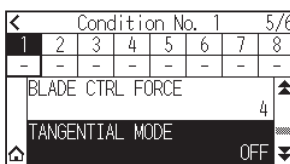

6. Press the mode you want to use.

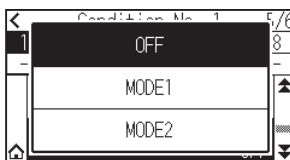

7. Press the [HOME] icon.

▶ It will return to HOME screen.

Setting the length of overcut

Set the length of overcut with tangential mode.

Operation

1. Press the [] icon.



2. Press the [EDIT CUT CONDITION].

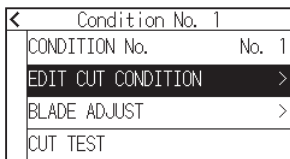

3. Press the [] icon five times.

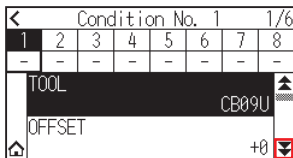

4. Press the tool condition number (1 to 8) you want to set.

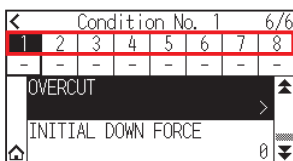

5. Press the [OVERCUT].

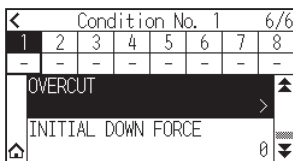

Supplement

It is enabled when Tangential Mode is set.

6. Press the [START].

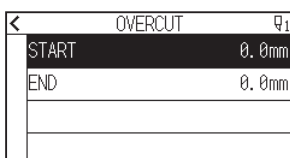

- Specify the setting value using the [▲] [▼] icon or the [⌂] icon.

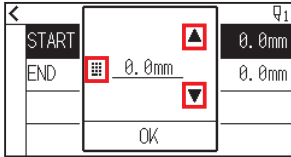

Supplement

You can set the range between 0.0 mm and 0.9 mm.

- Confirm the setting and press the [OK].
- Press the [END].

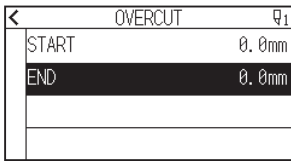

- Specify the setting value using the [▲] [▼] icon or the [⌂] icon.

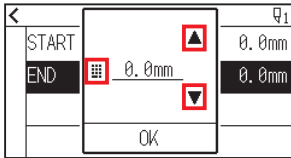

Supplement

You can set the range between 0.0 mm and 0.9 mm.

- Confirm the setting and press the [OK].
- Press the [◀] icon.
- Press the [🏠] icon.
▶ It will return to HOME screen.

Setting of the Initial Down Force

The initial down-force setting is effective when tangential mode is selected.

Tangential mode is generally used for the cutting of thick media. With thick film, additional time is required for the cutter blade to penetrate the media fully, even when the necessary cutting force is applied.

The cutting operation starts before the cutter blade has fully penetrated the media, causing uncut sections to be left.

When the initial down force is specified, this force is used as the cutting force immediately after the lowering of the tool when tangential mode is selected, enabling the cutter blade to penetrate the media rapidly. (As an example, if the cutting force is 25 and the initial down force is 4, for example, the cutting force applied immediately after the pen is lowered will be 29.) The upper limit for added value is 38.

Operation

- Press the [🏠] icon.

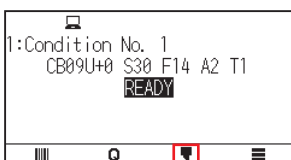

2. Press the [EDIT CUT CONDITION].

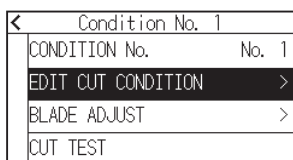

3. Press the [▼] icon five times.

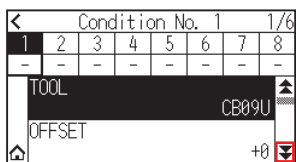

4. Press the tool condition number (1 to 8) you want to set.

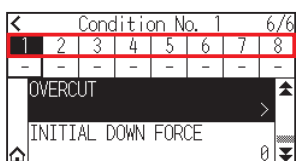

5. Press the [INITIAL DOWN FOECE].

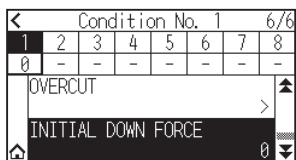

6. Specify the setting value using the [▲] [▼] icon or the [■] icon.

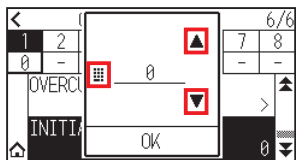

Supplement

You can set the range between 0 and 20.

7. Confirm the setting and press the [OK].
8. Press the [HOME] icon.
▶ It will return to HOME screen.

7.2 Setting the Step Pass

It may not cut the curved line smoothly if there is very short lines in the curve.

It will cut in the units of the specified value when the STEP PASS is used, which allows to control the short lines with certain length, resulting to stable rotation of the blade for higher cut quality.

Setting range of STEP PASS is from 0 to 20.

Actual length of the STEP PASS is the value of the STEP PASS multiplied by the distance set in the "STEP SIZE".

Supplement

- This setting will be saved even if the power is shut off.
- The cut image may not be what you intended if the set value is too large.
It is recommended to set to "1" for normal use.

Operation

1. Press the [≡] icon.

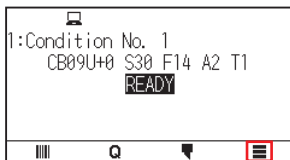

2. Press the [CONFIG].

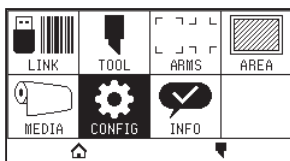

3. Press the [▼] icon.

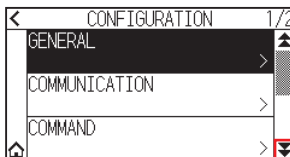

4. Press the [CUT QUALITY].

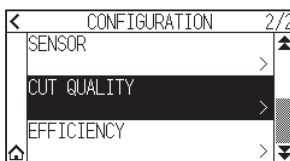

5. Press the [STEP PASS].

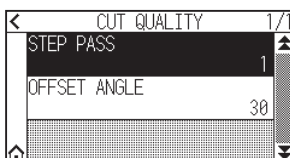

6. Specify the setting value using the [▲] [▼] icon or the [⌂] icon.

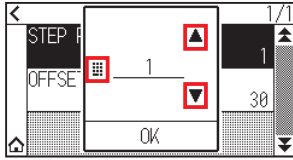

Supplement 

You can set the range between 0 and 20.

7. Confirm the setting and press the [OK].
8. Press the [⌂] icon.
▶ It will return to HOME screen.

7.3 Setting the Offset Angle

The CE8000 analyzes the cutting data, and controls the angle of the cutter blade tip if the change in the angles of the corner is large.

Angle control is applied if there is larger angle change than the angle specified as reference angle.

The time to cut is shortened by setting large value for the OFFSET ANGLE, since it will only apply blade control when there are angles with large angle change, hence this saves time and reduces the overall cutting time. But, if it is set too large, there will be not enough angle control of the blade, and the cut result may differ from what was expected. Set the reference angle in good balance.

Supplement

The setting will be saved even if the power is shut off.

Operation

1. Press the [≡] icon.

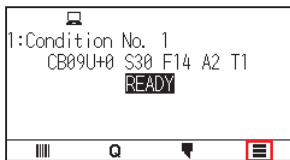

2. Press the [CONFIG].

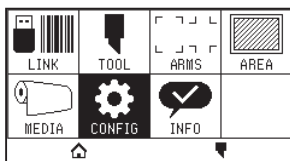

3. Press the [▼] icon.

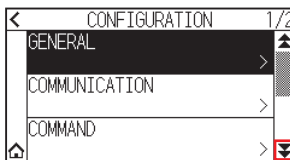

4. Press the [CUT QUALITY].

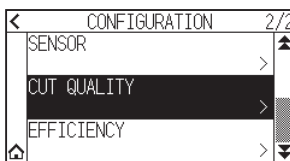

5. Press the [OFFSET ANGLE].

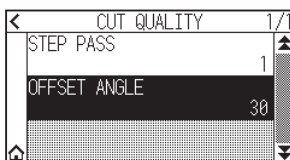

6. Specify the setting value using the [▲] [▼] icon or the [⌂] icon.

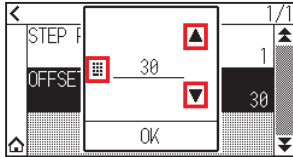

Supplement 

You can set the range between 0 and 60.

7. Confirm the setting and press the [OK].
8. Press the [⌂] icon.
▶ It will return to HOME screen.

7.4 Setting the Distance Adjust

DISTANCE ADJUST value corrects any deviation in the length of cut or plotted line segments, which occurs depending on the media being used.

DISTANCE ADJUST value for the deviation is specified as a percentage of the total distance. For example, a setting of +0.05% adjusts a distance of 2 m (2,000 mm) by $2,000 \times 0.05\% = 1$ mm, making 2,001 mm. DISTANCE ADJUST can be specified for each CONDITION No.

Supplement

This setting will be saved even if the power is shut off.

Operation

1. Press the [] icon.

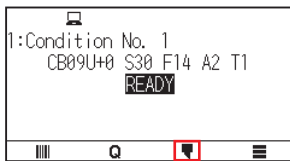

2. Press the [EDIT CUT CONDITION].

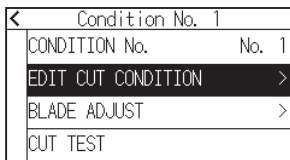

3. Press the [] icon three times.

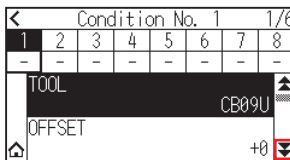

4. Press the tool condition number (1 to 8) you want to set.

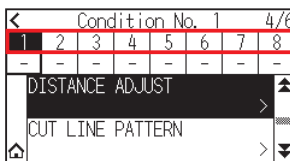

5. Press the [DISTANCE ADJUST].

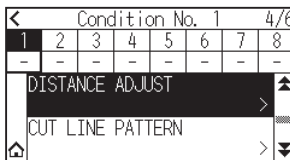

6. Press the [ENABLE FUNCTION] to turn it to [ON]. To cancel, set it to [OFF].

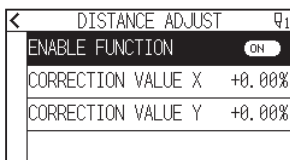

7. Press the [CORRECTION VALUE X].

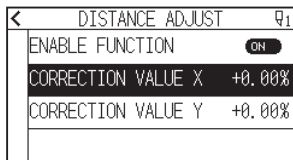

8. Specify the setting value using the [▲] [▼] icon or the [■] icon.

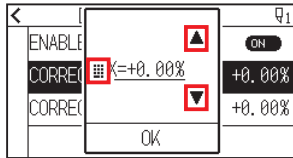

Supplement

You can set the range between -2.00% and +2.00%.

9. Confirm the setting and press the [OK].
10. Press the [CORRECTION VALUE Y].

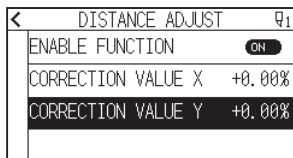

11. Specify the setting value using the [▲] [▼] icon or the [■] icon.

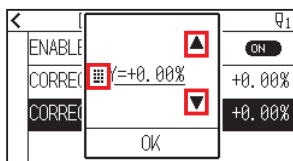

Supplement

You can set the range between -2.00% and +2.00%.

12. Confirm the setting and press the [OK].
13. Press the [◀] icon.
14. Press the [🏠] icon.
▶ It will return to HOME screen.

7.5 Setting Cut Line Pattern

To prevent cut media from falling off while you work, you can change the cutting line to the perforated lines. There are 8 different patterns of perforated lines set as 0 to 7, and the ratio of cut and uncut part differs in each. The uncut part becomes shorter with smaller value, making it easier to separate the cut parts. Every time the machine cuts 8 mm, the tool will be raised by the following length or the FORCE (cutting pressure) will be reduced to avoid cutting.

- Pattern 0: 0.15 mm
- Pattern 1: 0.20 mm
- Pattern 2: 0.25 mm
- Pattern 3: 0.30 mm
- Pattern 4: 0.35 mm
- Pattern 5: 0.40 mm
- Pattern 6: 0.45 mm
- Pattern 7: 0.50 mm

In addition to above 8 patterns, "OFF" which cuts by the solid line without perforation patter and "USER" where user can specify a unique pattern are provided.

The processing in the part is not cut with perforation patter is adjusted in "GAP ACTION".

The perforation patter can be set for each condition number.

Supplement

- Normally use it with default value OFF. It will cut with solid line.
- Use Tool Holder (forward) when cutting with any perforation pattern (aside from turning it off). See "2.2 Attaching a Tool" for detailed usage instructions.
- Doing a cut-out (cutting out) with a perforated pattern instead of a normal film cut (half cutting) can damage the cutting mat and the quality of a normal cut. Please make sure to use Tool Holder (backward).
- Replacing a cutting mat that was damaged by doing a perforated cut with use of Tool Holder (backward) will require a service fee.
- When the tool number is switched between the Tool No. 1 and the Tool No. 3 using the command from the computer, the following message will appear.

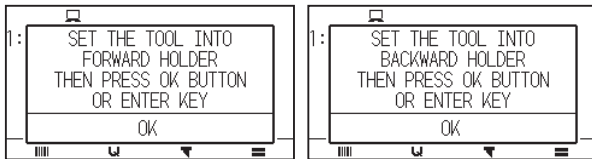

Please follow the message's instructions.

- The cut on the perforation pattern is shortened by 5 mm on the +X side (back of the media).

Operation

1. Press the [] icon.

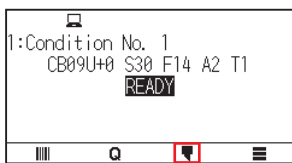

2. Press the [EDIT CUT CONDITION].

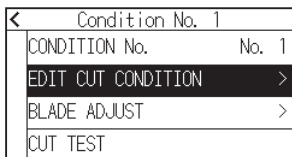

3. Press the [▼] icon three times.

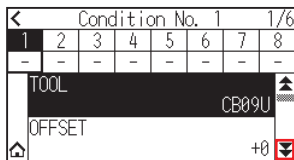

4. Press the tool condition number (1 to 8) you want to set.

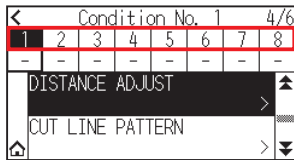

5. Press the [CUT LINE PATTERN].

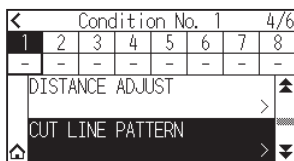

6. Press the [TYPE No.].

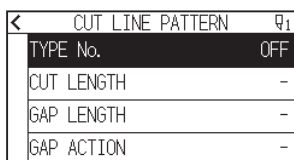

7. Display the TYPE No. you want to use using the [▼] and [▲] icons.

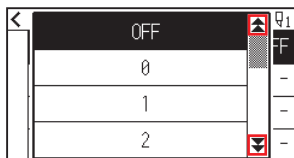

8. Press the Type No. you want to use.

9. Press the [GAP ACTION].

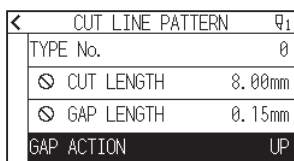

10. Specify the setting value using the [▲] [▼] icon or the [■] icon.

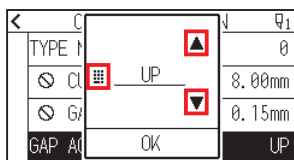

Supplement

- You can set the range between 1 and 38, or "UP".
- Value set here will be the cut force for the uncut part of the perforated lines.
Tool will be raised when set to "UP".
- Normally, input the smaller value than the FORCE for cutting to make it half cutting.

11. Confirm the setting and press the [OK].
12. If the "USER" is chosen in step 7, set the [CUT LENGTH] and [GAP LENGTH]. Follow steps 10 to 11 for this operation.

CUT LINE PATTERN ④	
TYPE No.	USER
CUT LENGTH	8.00mm
GAP LENGTH	0.60mm
GAP ACTION	UP

CUT LINE PATTERN ④	
TYPE No.	USER
CUT LENGTH	8.00mm
GAP LENGTH	0.60mm
GAP ACTION	UP

Supplement

- If the TYPE No. 0 to 7 is selected in step 7, CUT LENGTH and GAP LENGTH is only displayed, and not possible to change.
- Range possible to set for the CUT LENGTH is 0.01 mm to 500.0 mm.
- Range possible to set for the GAP LENGTH is 0.01 mm to 10.0 mm.

13. Press the [◀] icon.
14. Press the [🏠] icon.
 - ▶ It will return to HOME screen.

7.6 Setting Initial Blade Control Position Adjust

After turning on the power or changing pen condition settings, touch the blade to the media and adjust the blade direction. The Initial Blade Control Position will need to be set in order to make sure the area is not damaged and that the blade properly makes contact with the media.

Selecting "2mm BELOW" will change the Initial Blade Control Position to 2 mm below the cutting start point (2 mm from the edge of the point from which the media will be shifted.)

Selecting "Y OUTSIDE" will initialize Initial Blade Direction Setting outside the cutting area.

Selecting "SPECIFIED POSITION" will initialize Initial Blade Direction Setting at the Y direction fixed position that has been set.

* When media narrower than the set Y position is set, it will be the Y maximum value.

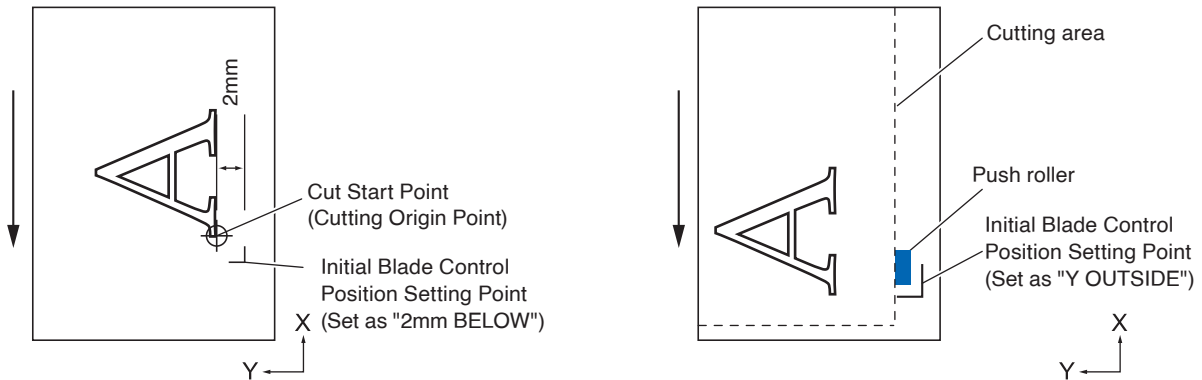

CAUTION

Selecting [Y OUTSIDE] and then changing the expand setting to a positive digit (8 mm ABOVE) can damage the cutting mat.

Operation

1. Press the [≡] icon.

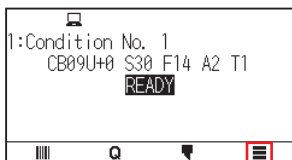

2. Press the [TOOL].

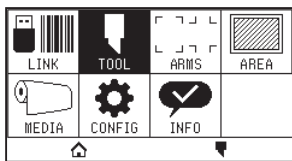

3. Press the [INITIAL B. ANGLE POSITION].

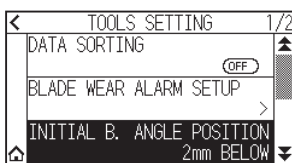

4. Press the blade initialization position you want to use.

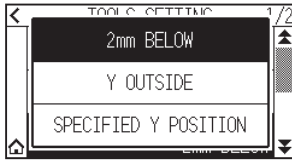

Supplement

- "Y SPECIFIED POSITION " is displayed when media is loaded.
- If you select [SPECIFIED Y POSITION] in the ready state, the following message will be displayed. Press the POSITION (▲, ▼, ◀, ▶) key to move the tool position, and press the [ENTER] key to set.

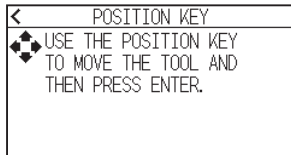

5. Press the [🏠] icon.
▶ It will return to HOME screen.

7.7 Setting the blade control force

Slight cut operation is performed before the actual cut operation to align the blade toward the cutting direction. Lower FORCE is necessary compared with the normal cutting, so it is possible to set lower FORCE as a BLADE CTRL FORCE.

BLADE CTRL FORCE is used to control the rotation of the blade with the tangential mode in addition to control the blade direction at the beginning of the cut.

Operation

1. Press the [] icon.



2. Press the [EDIT CUT CONDITION].

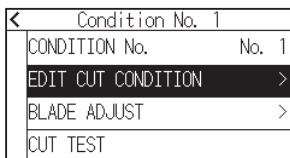

3. Press the [] icon four times.

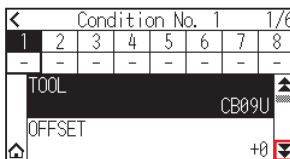

4. Press the tool condition number (1 to 8) you want to set.

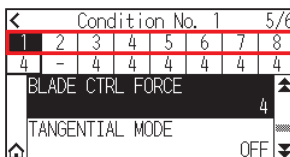

5. Press the [BLADE CTRL FORCE].

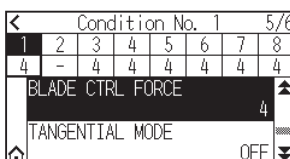

6. Specify the setting value using the [▲] [▼] icon or the [] icon.

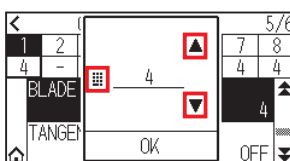

Supplement

You can set the range between 1 and 38.

7. Confirm the setting and press the [OK].
8. Press the [] icon.
 - ▶ It will return to HOME screen.

7.8 Setting Adjustment Between the Tools

If there is a misalignment between the tools, you can correct the misalignment by using this function.

If there is a misalignment in the cutting/plotting between Tool 1 (tool attached to the backward of the tool holder) and Tool 3 (tool attached to the forward of the tool holder), you can correct it by entering the adjustment value.

Supplement

Set "ASSIGN TOOL" of tool condition 1 to 1 and set "TOOL" to Pen.
Set "ASSIGN TOOL" of tool condition 2 to 3 and set "TOOL" to Cutter.

Operation

1. Press the [≡] icon.

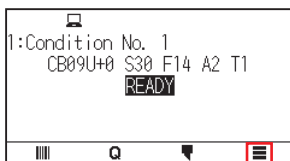

2. Press the [CONFIG].

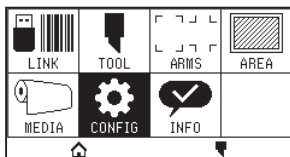

3. Press the [GENERAL].

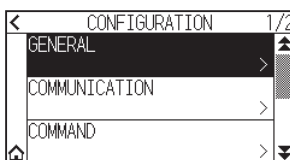

4. Press the [↓] icon.

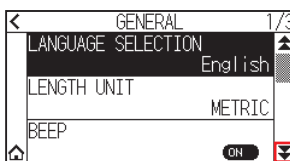

5. Press the [TOOL OFFSET ADJ.].

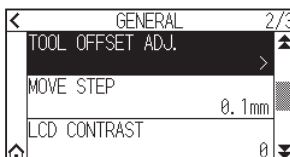

6. Press the [DRAW].

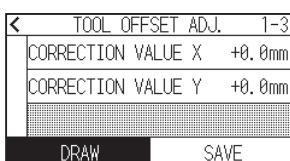

7. Press the POSITION (▲, ▼, ◀, ▶) keys to move the tool carriage and the media to the position where the test pattern is cut.
Move it inside of a cutting area greater than 50 mm on both the X and Y axes.

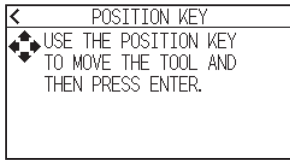

Supplement

Pressing the POSITION and [SLOW] keys at the same time moves the tool carriage slowly.

8. Confirm the tool position and press the [ENTER] key.
▶ Using the pen plunger (Tool 1), plot a "+" mark.
Next, using the pen plunger (Tool 3), plot a "+" mark.
When plotting is completed, TOOL OFFSET ADJ. screen is displayed.
9. Using "+" plotted with the pen plunger (Tool 1) as a reference, measure how much the "+" cut by the cutter plunger (Tool 3) deviates. (For example, in the case shown in the figure, it is deviated in the -X direction / + Y direction, so enter X = + * mm, Y = - * mm.)

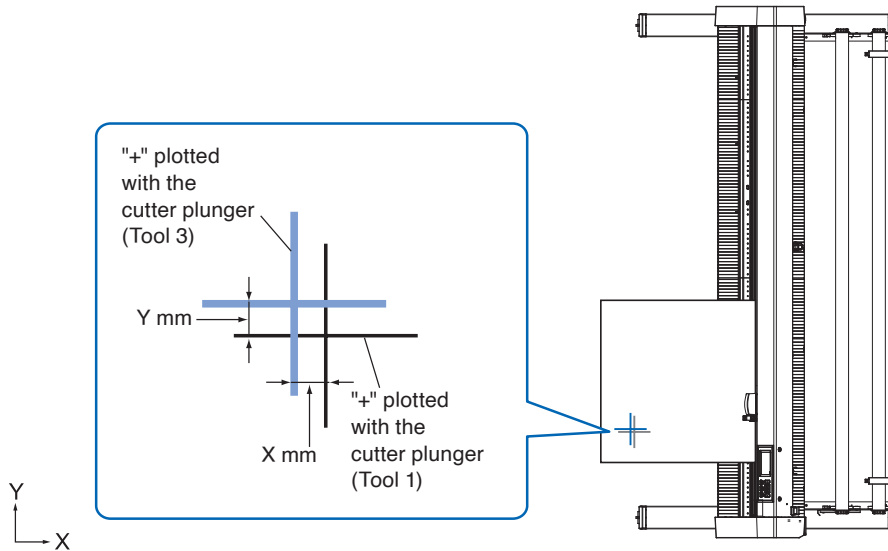

10. Press the [CORRECTION VALUE X].

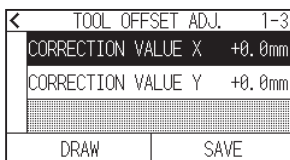

11. Specify the setting value using the [▲] [▼] icon or the [■] icon.

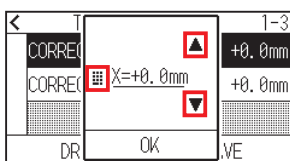

Supplement

You can set the range between -3.0 mm and +3.0 mm.

12. Confirm the setting and press the [OK].

13. Press the [CORRECTION VALUE Y].

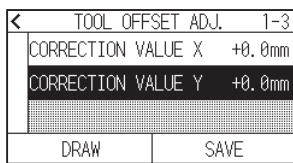

14. Specify the setting value using the [▲] [▼] icon or the [] icon.

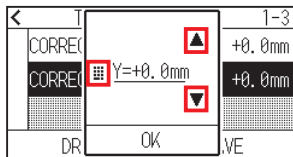

Supplement

You can set the range between -3.0 mm and +3.0 mm.

15. Confirm the setting and press the [OK].

16. Repeat steps 6 to 14 until the misalignment between the two tools is corrected.

17. Press the [SAVE].

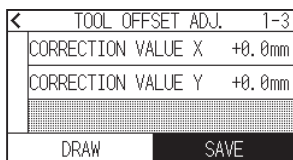

18. Press the [◀] icon.

19. Press the [🏠] icon.

▶ It will return to HOME screen.

Chapter 8: Settings Regarding Cutting Time

This chapter describes the settings affecting the cutting time.

SECTION IN THIS CHAPTER

- 8.1 Sorting the Cutting Data*
- 8.2 Perform Automatic Pre Feed When Cut Data is Received*
- 8.3 Setting Feed Speed for Pre Feed*
- 8.4 Setting the Moving Speed*
- 8.5 Setting the Shortcut Move*
- 8.6 Setting the Tool Up Height*

8.1 *Sorting the Cutting Data*

When sorting cutting/plotting data, cutting is performed collectively so that the amount of movement in the media feed direction and the tool replacement time are minimized, so cutting operation is improved efficiently. This function sorts so that the amount of movement in the media feed direction is minimized, so it is effective for plotting data where the tool is raised to the cutting position and moves here and there.

Supplement

- Sorting will start the process after all the data are stored in the buffer memory, so it takes time to start the cutting.
- Sorting might not be effective for the data that is created efficiently.
- Process may be faster to turn off the sorting on the plotter, if the data is already sorted using the software on the PC.

Operation

1. Press the [≡] icon.

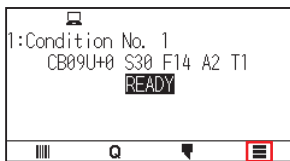

2. Press the [TOOL].

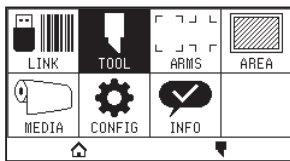

3. Press [DATA SORTING] to turn it to [ON].
To cancel, set it to [OFF].

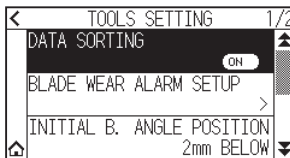

4. Press the [HOME] icon.
▶ It will return to HOME screen.

Supplement

When the setting is turned ON, a [≡] mark will be displayed at the top of the screen.

8.2 Perform Automatic Pre Feed When Cut Data is Received

It is possible to feed and reverse the media automatically for specified amount when the plotter receives the cutting data.

"Pre feeding" to prevent the shifting of media can be done automatically.

Also, the media will be unrolled from the roll before cutting when rolled media is to be used.

Supplement

- The setting for AUTO PRE FEED when cutting data is received is maintained even if the power is turned off.
- Setting of the AUTO PRE FEED length is not linked to the setting of the page length. Change the setting for the page length if the cutting area is to be long.
- If data is received and auto media transfer is performed once, even if (cut in the same area) data is received again, auto media transfer will not take place.

Operation

1. Press the [≡] icon.



2. Press the [MEDIA].

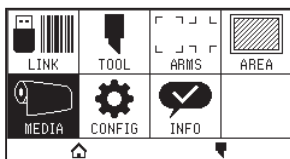

3. Press the [AUTO PRE FEED].

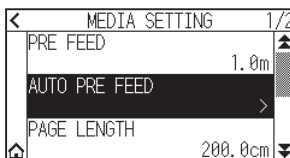

4. Press [ENABLE FUNCTION] to turn it to [ON].
To cancel, set it to [OFF].

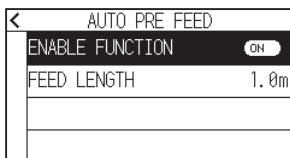

5. Press the [FEED LENGTH].

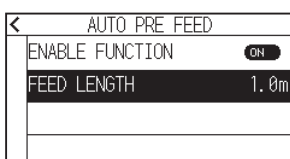

6. Specify the setting value using the [▲] [▼] icon or the [⌂] icon.

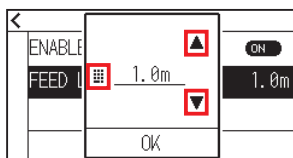

Supplement

- You can set the range between 0.5 m and 50.0 m.
- Feed length can be set in 0.1 m units.

7. Confirm the setting and press the [OK].
8. Press the [<] icon.
9. Press the [⌂] icon.
- ▶ It will return to HOME screen.

Supplement

When the setting is turned ON, a [⊕] mark will be displayed at the top of the screen.

8.3 Setting Feed Speed for Pre Feed

Set the speed of media feed such as the feed (media carry) of auto media of received cut/plotting data.
Set the feed speed to "SLOW" if the media shifts during the Pre Feed when the heavy or slippery media is to be used. It is normally set to "NORMAL".

Supplement

This setting will be saved even if the power is shut off.

Operation

1. Press the [≡] icon.

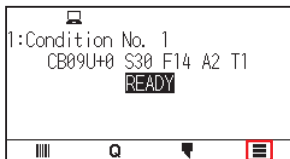

2. Press the [MEDIA].

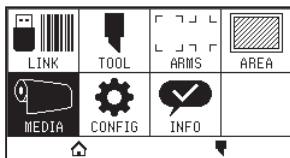

3. Press the [▼] icon.

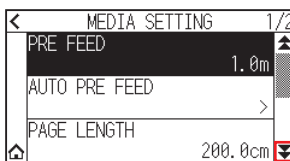

4. Press the [FEED SPEED].

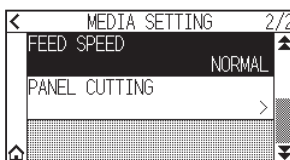

5. Press the feeding speed you want to use.

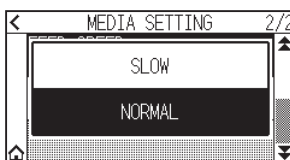

6. Press the [HOME] icon.

▶ It will return to HOME screen.

8.4 Setting the Moving Speed

Moving speed is the speed the tool moves when it is raised (tool up state).

The cutting time in total becomes short if you set the MOVING SPEED to fast speed even though the speed of the tool when it is cutting (lowered) is set to slow speed for the hard to cut media (hard or sticky).

Supplement

This setting will be saved even if the power is shut off.

Operation

1. Press the [≡] icon.



2. Press the [CONFIG].

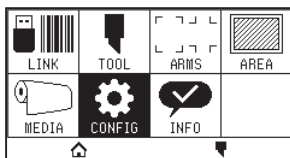

3. Press the [▼] icon.

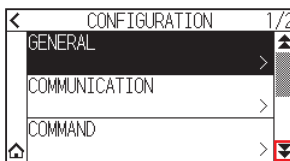

4. Press the [EFFICIENCY].

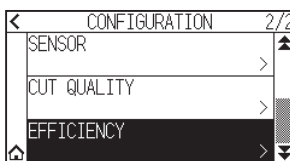

5. Press the [MOVING SPEED].

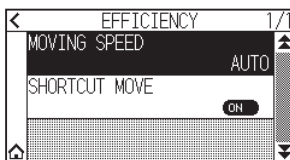

6. Use the [▼] and [▲] icons to display the [MOVING SPEED] to be used.

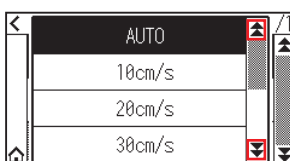

Supplement

- You can set to AUTO, 10 cm/s, 20 cm/s, 30 cm/s, 40 cm/s, 50 cm/s or 60 cm/s.
- It will be same speed as tool is lowered when AUTO is selected.

7. Press the moving speed you want to use.
8. Press the [] icon.
 - ▶ It will return to HOME screen.

8.5 Setting the Shortcut Move

When the plotter received coordinate information for moving with the tool up is continuously from a computer connected, you can set whether to move to each coordinate in turn or move directly to the final coordinate using the "SHORTCUT MOVE".

There are following 2 settings for "SHORTCUT MOVE".

OFF: If several coordinates are received continuously, it will move to each in order it is received.

ON: If several coordinates are received continuously, it will directly move to the last coordinate received.

Cutting/plotting time can be reduced if it is set to "ON", if the time to move the tool in raised status is wasteful.

Supplement

This setting will be saved even if the power is shut off.

Operation

1. Press the [≡] icon.



2. Press the [CONFIG].

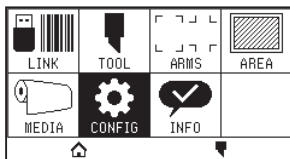

3. Press the [↓] icon.

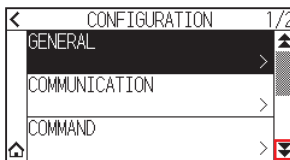

4. Press the [EFFICIENCY].

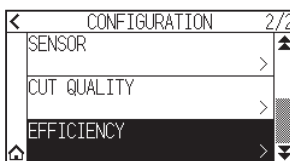

5. Press [SHORTCUT MOVE] to turn it to [ON].
To cancel, set it to [OFF].

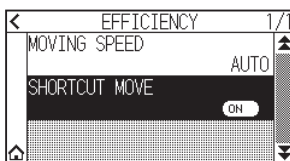

6. Press the [HOME] icon.
▶ It will return to HOME screen.

8.6 Setting the Tool Up Height

The TOOL UP HEIGHT is the height of the tool position when the tool is raised.
Set to "HIGHER POSITION" if the media is thick. Usually, set to the "NORMAL POSITION".

Supplement

This setting will be saved even if the power is shut off.

Operation

1. Press the [≡] icon.

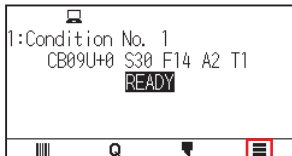

2. Press the [TOOL].

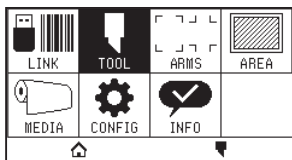

3. Press the [▼] icon.

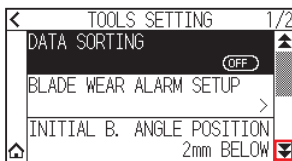

4. Press the [TOOL UP HEIGHT].

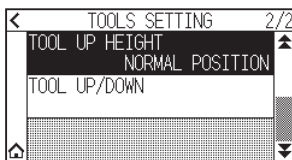

5. Press the tool up height you want to use.

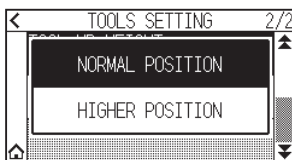

6. Press the [HOME] icon.

▶ It will return to HOME screen.

Chapter 9: Settings Regarding Interface

This chapter describes setting regarding interface.

SECTION IN THIS CHAPTER

- 9.1 Setting Interface*
- 9.2 Connecting via wireless LAN*
- 9.3 Connecting via wired LAN*
- 9.4 Clearing buffer memory*

9.1 Setting Interface

This section describes how to set the interface.

The plotter has USB, Wireless LAN and Wired LAN* interfaces, and these interfaces are switched automatically. If the cutting/plotting data is sent from multiple interfaces, the plotter will start cutting/plotting from the first data it receives.

To use the interfaces on this plotter, you need to install the driver software on the PC.

* Wired LAN unit is factory-installed option.

USB interface

To use the USB interface, the driver software must be installed in the computer. Please the SETUP MANUAL to install the driver software.

CAUTION

- Operation cannot be guaranteed in the following cases:
 - When the plotter is connected to a USB hub or extension port.
 - When the plotter is connected to a hand-built or modified computer.
 - When using a driver other than the one specifically designed for CE8000.
- Notes when using the USB 3.0 interface
 - Because that some computer equipped with a USB 3.0 interface is not compatible with USB 2.0 or later interface, you need to check it.
- Do not perform the followings:
 - Do not connect or disconnect the USB cable while installing the USB driver on the computer.
 - Do not connect or disconnect the USB cable when the computer or the plotter is performing an initialization routine. Do not disconnect the USB cable within a 5-second period of connecting it.
 - Do not disconnect the cable during data transfer.
- Please use a USB 2.0 (Hi-Speed) compatible USB cable with a length of less than 3 m.

Wireless LAN, Wired LAN interfaces

To use a wireless LAN or wired LAN interface, you need to set up your computer and have an environment that allows you to connect the computer to a network. Also, temporarily turn off the firewall function or change its settings.

If you turn off the firewall function, disconnect your network from the Internet.

CAUTION

- To connect through a LAN, you need a network cable and a network hub and a wireless LAN router. Please purchase them separately.
- Network configuration depends on your environment. For details, please see the equipment manual, or consult the manufacturer or network administrator.
- Ethernet is compliant with 10BASE-T/100BASE-TX. Please check your network environment.
- Wireless LAN standard supports 802.11 b/g/n (2.4 GHz). It does not support 5GHz bands such as 802.11a.

9.2 Connecting via wireless LAN

Configure settings when connecting using wireless LAN.

* If the wireless LAN module is not installed, [] will be displayed on the menu and you will not be able to open the setting items.

When connecting via wireless LAN, set the following items.

- Access point setting
- Entering the IP address
- Entering the subnet mask
- Gateway input
- DHCP setting

Access point setting

Access point settings depend on the network device configuration and your environment.

For details, please see your device's manual or consult your network administrator.

Operation

1. Press the [] icon.

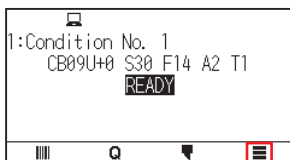

2. Press the [CONFIG].

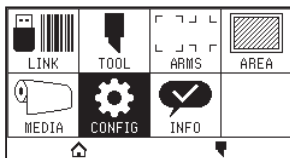

3. Press the [COMMUNICATION].

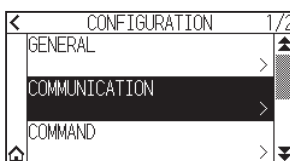

4. Press the [WIRELESS LAN] icon.

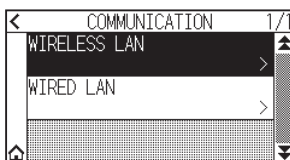

5. Press [WIRELESS LAN] to turn it to [ON].
To cancel, set it to [OFF].

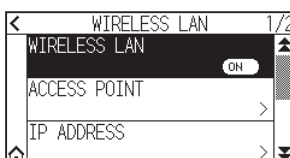

- Press the [ACCESS POINT].

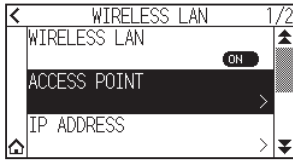

Supplement

If no connectable access point is found, the following screen will be displayed. Please check the status of your wireless LAN router.

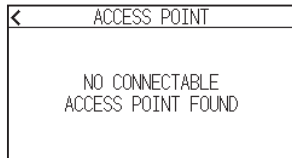

- Use the [▼] and [▲] icons to display the access point to be used.

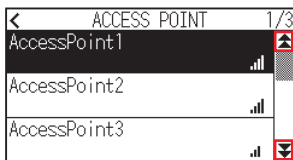

Supplement

If the access point you want to connect is not displayed, press [◀] to return to the previous screen, then press [ACCESS POINT] again to update the access point.

- Press the access point you want to use.
- Enter the encryption key for the access point you want to use.

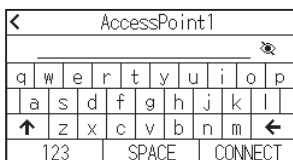

Supplement

- Press the [↑] button to switch between uppercase and lowercase letters.
- By pressing the [123] button, you can switch the character type in the order of alphabets, numbers, symbols and Hex.
- If you enter one or more letters, numbers or symbols, you cannot switch to Hex.
- If you enter one or more characters in Hex, you cannot switch to alphabets, numbers or symbols.
- When entering in hex, the number of characters must be an even number.
- Press the [👁] button to show or hide (*) the encryption key string.
- Encryption key is saved for the last two access points you connected to.

10. Confirm the entered information and press the [CONNECT].

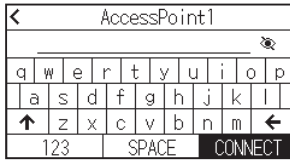

Supplement

If an error message is displayed, check the contents of the error message and reconfigure settings again.

11. Press the [YES].

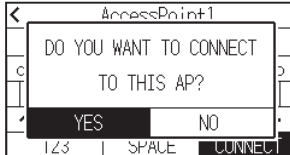

Supplement

When connected to an access point, a check mark will be displayed to the right of the access point name.

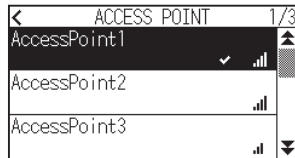

12. Press the [←] icon.

13. Press the [🏠] icon.

▶ It will return to HOME screen.

Set IP address, subnet mask and gateway

When [OFF] is selected in DHCP setting, set these items.

When [ON] is selected in the DHCP setting, the IP address, subnet mask and gateway obtained from the DHCP server are displayed.

Operation

1. Press the [☰] icon.

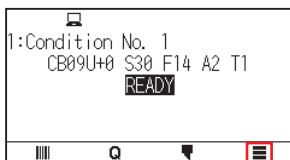

2. Press the [CONFIG].

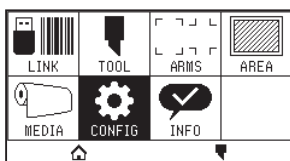

3. Press the [COMMUNICATION].

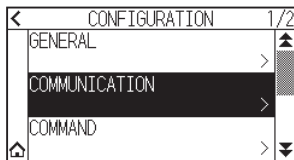

4. Press the [WIRELESS LAN].

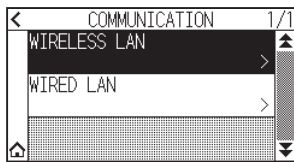

5. Press the [IP ADDRESS].

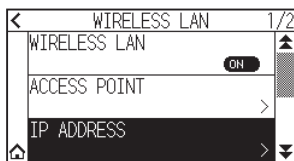

6. Press the [IP ADDRESS].

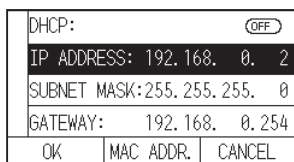

7. Press the separated numbers you want to set.

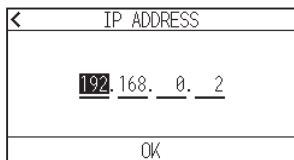

8. Enter the numbers you want to set and press the [OK].

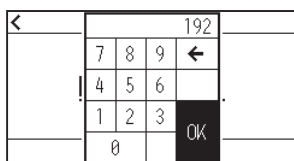

9. Confirm the numbers and press the [OK].

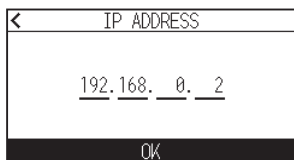

Supplement

- If you want to change the numbers for other separated numbers, repeat steps 7 and 8.
- If the IP address is the same as the wired LAN IP address, an error screen will be displayed. Enter a different IP address from the wired LAN.

10. Press the [SUBNET MASK].

DHCP: (OFF)		
IP ADDRESS: 192.168. 0. 2		
SUBNET MASK: 255. 255. 255. 0		
GATEWAY: 192.168. 0. 254		
OK	MAC ADDR.	CANCEL

11. Press the separated numbers you want to set.

< SUBNET MASK			
255. 255. 255. 0			
OK			

12. Enter the numbers you want to set and press the [OK].

<			255		
7	8	9	←		
4	5	6	.		
1	2	3	OK		
0					

13. Confirm the numbers and press the [OK].

< SUBNET MASK			
255. 255. 255. 0			
OK			

Supplement 

If you want to change the numbers for other separated numbers, repeat steps 11 and 12.

14. Press the [GATEWAY].

DHCP: (OFF)		
IP ADDRESS: 192.168. 0. 2		
SUBNET MASK: 255. 255. 255. 0		
GATEWAY: 192.168. 0. 254		
OK	MAC ADDR.	CANCEL

15. Press the separated numbers you want to set.

< GATEWAY			
192. 168. 0. 254			
OK			

16. Enter the numbers you want to set and press the [OK].

<			192		
7	8	9	←		
4	5	6	.		
1	2	3	OK		
0					

17. Confirm the numbers and press the [OK].

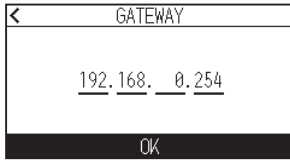

Supplement

If you want to change the numbers for other separated numbers, repeat steps 15 and 16.

18. Press the [OK].

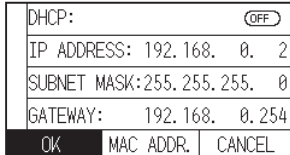

Supplement

- If you change the settings, the plotter will automatically restart and return to the HOME screen.
- If you didn't change any settings, proceed to step 19.
- Press the [MAC ADDR.] button to display the MAC address.

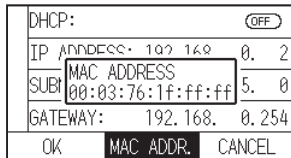

19. Press the [] icon.

▶ It will return to HOME screen.

DHCP setting

DHCP settings depends on the network device configuration and your environment. For details, see your device's manual or consult your network administrator. The default value of DHCP is [OFF].

Supplement

Although the DHCP depends on the settings of the DHCP server, if the DHCP setting is turned on, the IP address of this plotter may change every time the power is turned on. Changing the IP address may cause problems such as not being able to receive data from the computer. In order to avoid such problems, we recommend that you turn off the DHCP settings.

Operation

1. Press the [] icon.

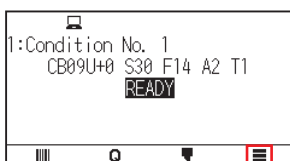

2. Press the [CONFIG].

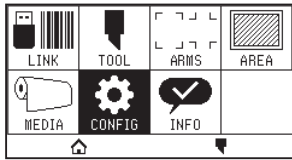

3. Press the [COMMUNICATION].

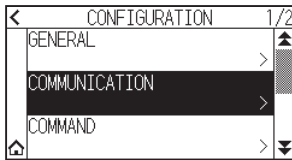

4. Press the [WIRELESS LAN].

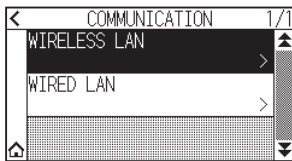

5. Press the [IP ADDRESS].

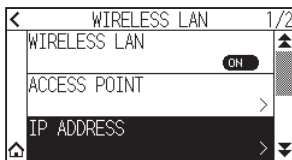

6. Press [DHCP] to turn it to [ON].
To cancel, set it to [OFF].

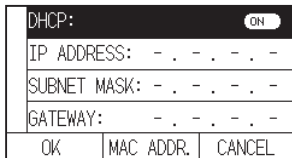

7. Press the [OK].

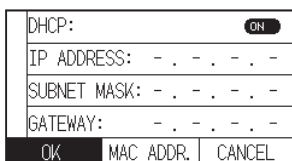

Supplement

- If you change the settings, the plotter will automatically restart and return to the HOME screen.
- If you do not change any settings, proceed to step 8.

8. Press the [] icon.

▶ It will return to HOME screen.

Confirming the connection information

The SSID and encryption standard, etc. related to the connected access point are displayed.

Operation

1. Press the [≡] icon.



2. Press the [CONFIG].

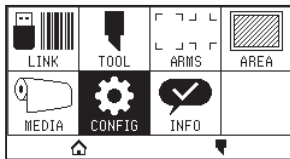

3. Press the [COMMUNICATION].

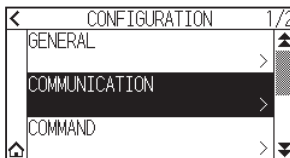

4. Press the [WIRELESS LAN].

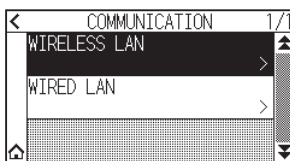

5. Press the [▼] icon.

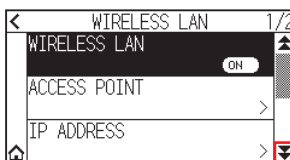

6. Press the [CONNECTION INFO].

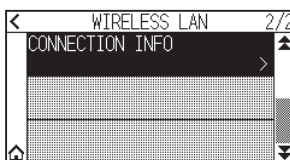

7. Information about the connection is displayed.



8. Press the [◀] icon.

9. Press the [HOME] icon.

▶ It will return to HOME screen.

9.3 Connecting via wired LAN

This section explains the settings when connecting via wired LAN.

* Wired LAN unit is factory-installed option.

* If the wired LAN module is not installed, [--] will be displayed on the menu and you will not be able to open the setting items.

When connecting via wired LAN, set the following items.

- Entering the IP address
- Entering the subnet mask
- Entering the gateway
- DHCP setting

IP address, subnet mask and gateway settings

Set the IP address when selecting the [OFF] in the DHCP setting.

If you select the [ON] in the DHCP setting, the IP address, subnet mask and gateway obtained from the DHCP server will be displayed.

Operation

1. Press the [≡] icon.

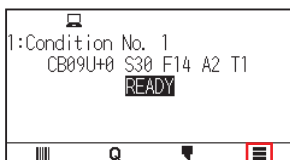

2. Press the [CONFIG].

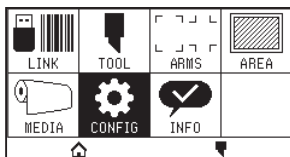

3. Press the [COMMUNICATION].

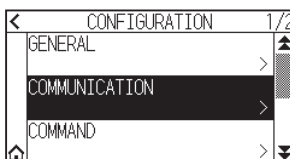

4. Press the [WIRED LAN].

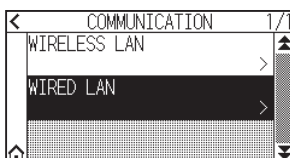

5. Press the [IP ADDRESS].

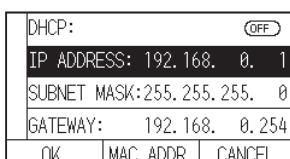

6. Press the separated numbers you want to set.

IP ADDRESS						
192	.	168	.	0	.	1
OK						

7. Enter the numbers you want to set and press the [OK].

192			
7	8	9	←
4	5	6	.
1	2	3	
0			OK

8. Confirm the numbers and press the [OK].

IP ADDRESS						
192	.	168	.	0	.	1
OK						

Supplement

- If you want to change the numbers for other separated numbers, repeat steps 6 and 7.
- If the IP address is the same as the wireless LAN IP address, an error screen will be displayed. Enter a different IP address from the wireless LAN.

9. Press the [SUBNET MASK].

DHCP:		OFF
IP ADDRESS:		192.168. 0. 1
SUBNET MASK:		255.255.255. 0
GATEWAY:		192.168. 0.254
OK	MAC ADDR.	CANCEL

10. Press the separated numbers you want to set.

SUBNET MASK						
255	.	255	.	255	.	0
OK						

11. Enter the numbers you want to set and press the [OK].

255			
7	8	9	←
4	5	6	.
1	2	3	
0			OK

12. Confirm the numbers and press the [OK].

SUBNET MASK						
255	.	255	.	255	.	0
OK						

Supplement

If you want to change the numbers for other separated numbers, repeat steps 10 and 11.

13. Press the [GATEWAY].

DHCP: (OFF)		
IP ADDRESS: 192.168. 0. 1		
SUBNET MASK: 255. 255. 255. 0		
GATEWAY: 192.168. 0. 254		
OK	MAC ADDR.	CANCEL

14. Press the separated numbers you want to set.

GATEWAY		
192.168. 0. 254		
OK		

15. Enter the numbers you want to set and press the [OK].

192		
7	8	9
4	5	6
1	2	3
0		
OK		

16. Confirm the numbers and press the [OK].

GATEWAY		
192.168. 0. 254		
OK		

Supplement

If you want to change the numbers for other separated numbers, repeat steps 14 and 15.

17. Press the [OK].

DHCP: (OFF)		
IP ADDRESS: 192.168. 0. 1		
SUBNET MASK: 255. 255. 255. 0		
GATEWAY: 192.168. 0. 254		
OK	MAC ADDR.	CANCEL

Supplement

- If you change the settings, the plotter will automatically restart and return to the HOME screen.
- If you do not change any settings, proceed to step 18.
- Press the [MAC ADDR.] button to display the MAC address.

DHCP: (OFF)		
IP ADDRESS: 192.168. 0. 1		
SUBNET MASK: 255. 255. 255. 0		
MAC ADDRESS: 00:03:76:1f:ff:ff 5. 0		
GATEWAY: 192.168. 0. 254		
OK	MAC ADDR.	CANCEL

18. Press the [] icon.

▶ It will return to HOME screen.

DHCP setting

DHCP settings depends on the network device configuration and your environment.
For details, see your device's manual or consult your network administrator.
The default value of DHCP is [OFF].

Supplement

Although the DHCP depends on the settings of the DHCP server, if the DHCP setting is turned on, the IP address of this plotter may change every time the power is turned on.
Changing the IP address may cause problems such as not being able to receive data from the computer.
In order to avoid such problems, we recommend that you turn off the DHCP settings.

Operation

1. Press the [≡] icon.

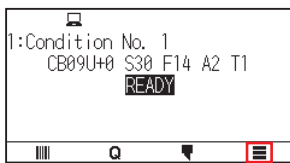

2. Press the [CONFIG].

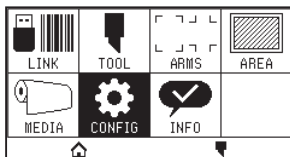

3. Press the [COMMUNICATION].

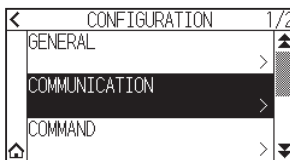

4. Press the [WIRED LAN].

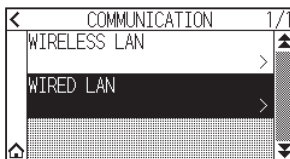

5. Press [DHCP] to turn it to [ON].
To cancel, set it to [OFF].

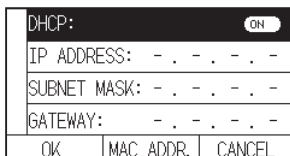

6. Press the [OK].

DHCP:	<input checked="" type="checkbox"/>	ON
IP ADDRESS:	- . - . - . -	
SUBNET MASK:	- . - . - . -	
GATEWAY:	- . - . - . -	
OK	MAC ADDR.	CANCEL

Supplement 

- If you change the settings, the plotter will automatically restart and return to the HOME screen.
- If you do not change any settings, proceed to step 7.

7. Press the [] icon.

▶ It will return to HOME screen.

9.4 Clearing buffer memory

Erases output data in buffer memory.

Operation

1. Press the [≡] icon.



2. Press the [CONFIG].

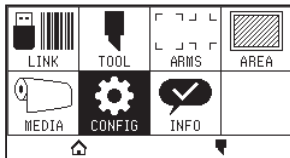

3. Press the [COMMAND].

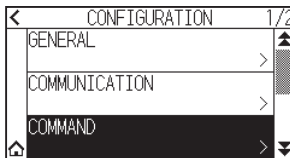

4. Press the [▼] icon.

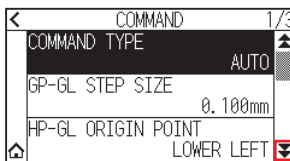

5. Press the [BUFFER CLEAR].

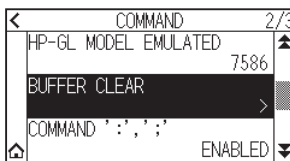

6. Press the [YES, CLEAR].

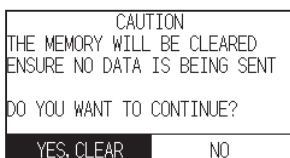

▶ The buffer memory will be cleared and it will return to HOME screen.

Chapter 10: Settings Regarding Operation Environment

This chapter describes settings regarding the operation environment.

SECTION IN THIS CHAPTER

10.1 Related to Menu Display

10.2 Related to sensor

10.3 Plotter Environment-related Settings

10.1 Related to Menu Display

Make settings related to menu display.

Display language setting (LANGUAGE SELECTION)

This function sets the language used on the display.

One of ten languages can be selected: English, Japanese, German, French, Italian, Spanish, Portuguese, Russian, Korean, and Chinese.

Operation

1. Press the [≡] icon.

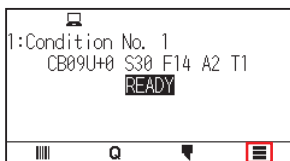

2. Press the [CONFIG].

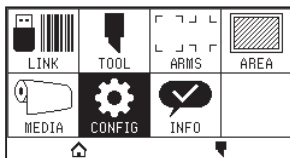

3. Press the [GENERAL].

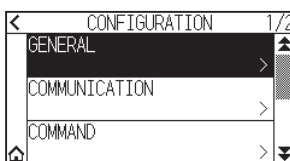

4. Press the [LANGUAGE SELECTION].

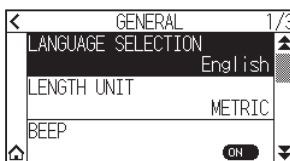

5. Use the [↓] and [↑] icons to display the language you want to use.



6. Press the language you want to use.

7. Press the [HOME] icon.

▶ It will return to HOME screen.

Display Length Unit Setting (LENGTH UNIT)

The coordinate values that appear on the display and the other parameters for various settings can be changed to either meter or inch display.

Operation

1. Press the [≡] icon.

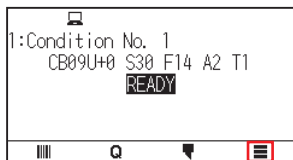

2. Press the [CONFIG].

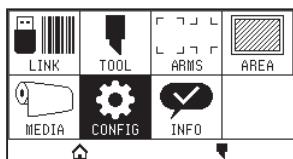

3. Press the [GENERAL].

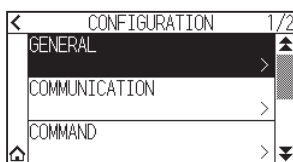

4. Press the [LENGTH UNIT].

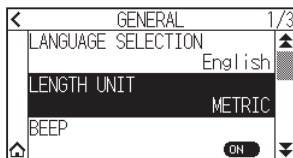

5. Press the length unit you want to use.

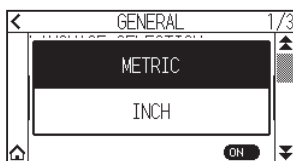

7. Press the [HOME] icon.

▶ It will return to HOME screen.

10.2 Related to sensor

This section describes how to make the sensor-related settings.

Enabling/Disabling the media sensors

You can disable the sensors that detect the presence or absence of media and the size of the medium in the feed direction.

If you want to enable it, set it back to "ENABLED" here.

⚠ CAUTION

Normally, please use it while set to "ENABLED". Turn it DISABLED when setting undetectable media with high transmittance.

When set to "DISABLED", the cutting mat may be damaged. Please be sure to configure the "area".

Operation

1. Press the [≡] icon.

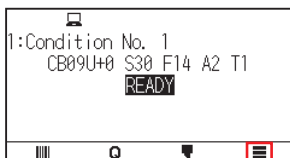

2. Press the [CONFIG].

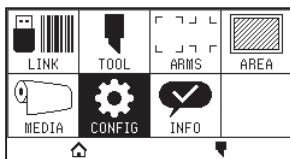

3. Press the [↓] icon.

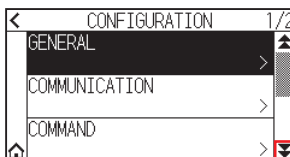

4. Press the [SENSOR].

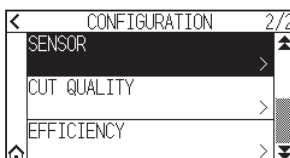

5. Press the [MEDIA SENSOR].

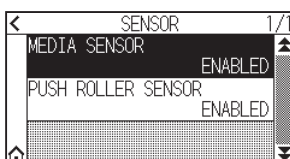

6. Press the [ENABLED] or the [DISABLED] for the sensor.

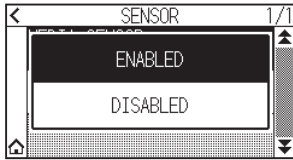

7. Press the [HOME] icon.
▶ It will return to HOME screen.

Enabling/Disabling the push roller sensors

Set the push roller sensors that detect the width of the media to "DISABLED".
If you want to enable it, set it to "ENABLED" here.

CAUTION

Usually, please use it while set to "Enabled".
When set to "Disabled", the cutting mat may be damaged. Please always set the "Cutting Area".

Operation

1. Press the [≡] icon.

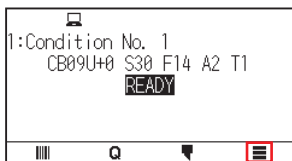

2. Press the [CONFIG].

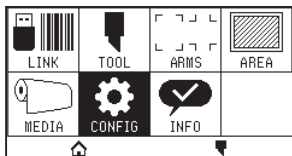

3. Press the [▼] icon.

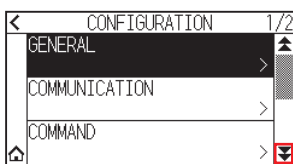

4. Press the [SENSOR].

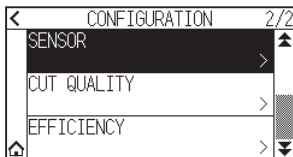

5. Press the [PUSH ROLLER SENSOR].

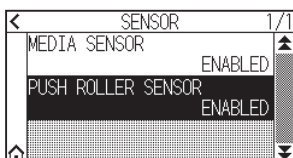

6. Press the [ENABLED], [INSIDE DISABLED] or [DISABLED] for the sensor.

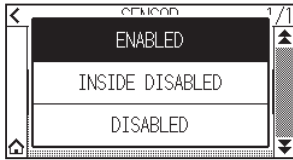

Supplement

- "INSIDE DISABLED" is displayed for CE8000-130.
- It will not generate error even if the inner push rollers are not on the grit rollers when the "INSIDE DISABLED" is selected.
- When "DISABLE" has been set, the home sensor position is not detected, so depending on the data, a position error could occur. Please always set the "CUT AREA".

7. Press the [] icon.
- ▶ It will return to HOME screen.

10.3 Plotter Environment-related Settings

This section describes how to make the plotter environment-related settings.

Fan suction setting

This function sets the suction force used to affix media to the plotter. It may not feed properly if the media is thin, so set to "WEAK".

Operation

1. Press the [≡] icon.

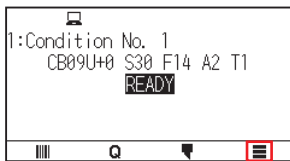

2. Press the [CONFIG].

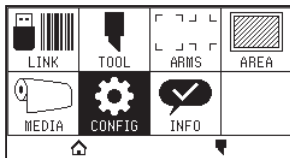

3. Press the [GENERAL].

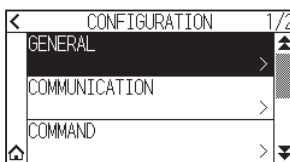

4. Press the [▼] icon twice.

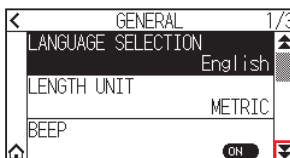

5. Press the [FAN POWER].

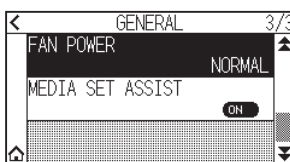

6. Press the setting value you want to use.

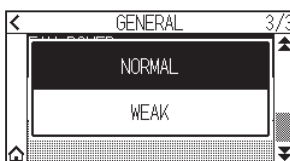

7. Press the [HOME] icon.

▶ It will return to HOME screen.

Media set assist settings

Media set assist is an auxiliary function that operates a suction fan when loading media to make it easier to load the media.

Supplement

- Depending on the type of media, using Media Set Assist may make it difficult to set the media. In this case, please make the setting to [OFF].
- The strength of suction is linked to the [FAN] setting.
- Media set assist operates when the media sensor detects media while the HOME screen is displayed (only while the media set lever is down).

Operation

1. Press the [≡] icon.

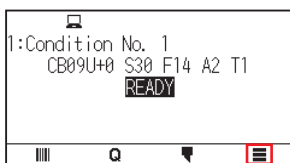

2. Press the [CONFIG].

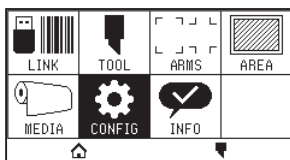

3. Press the [GENERAL].

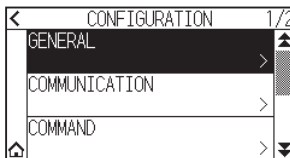

4. Press the [▼] icon twice.

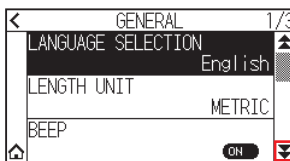

5. Press [MEDIA SET ASSIST] to turn it to [ON].
To cancel, set it to [OFF].

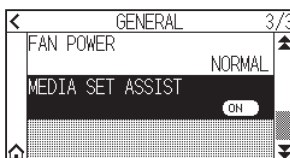

Supplement

The default value has been set to [ON].

6. Press the [HOME] icon.
▶ It will return to HOME screen.

Enabling/Disabling the beep setting

You can turn off the buzzer sound.

If you want to enable the buzzer sound again, set it here.

Operation

1. Press the [≡] icon.

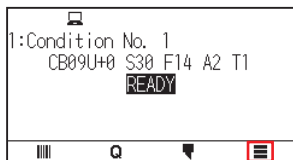

2. Press the [CONFIG].

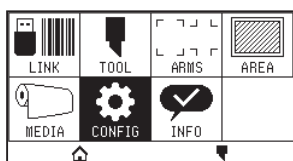

3. Press the [GENERAL].

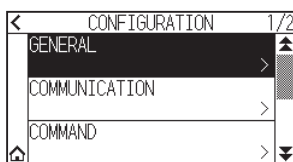

4. Press [BEEP] to turn it to [ON].
To cancel, set it to [OFF].

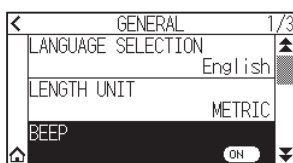

5. Press the [HOME] icon.
▶ It will return to HOME screen.

LCD contrast setting

You can set the contrast of the LCD display on the control panel.

Operation

1. Press the [≡] icon.

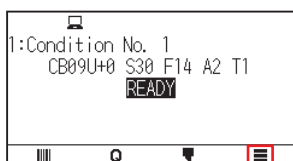

2. Press the [CONFIG].

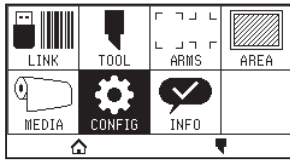

3. Press the [GENERAL].

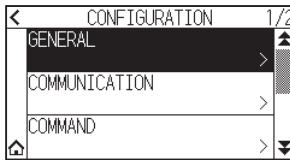

4. Press the [▼] icon.

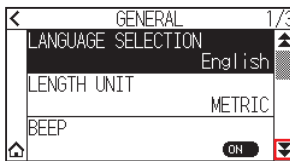

5. Press the [LCD CONTRAST].

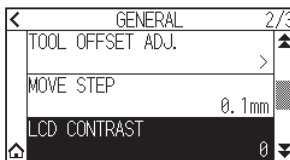

6. Specify the setting value using the [▲] [▼] icon or the [■] icon.

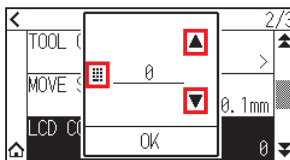

Supplement

You can set the range between -30 and 30 (5 steps).

7. Confirm the setting and press the [OK].

8. Press the [HOME] icon.

▶ It will return to HOME screen.

Chapter 11: Settings of Controls from Computer

This chapter describes settings regarding the controls from the computer.

SECTION IN THIS CHAPTER

- 11.1 Settings Related to Command Processing*
- 11.2 Related to GP-GL command*
- 11.3 Related to HP-GL command*

11.1 Settings Related to Command Processing

Make settings related to command processing.

Setting the command

There are 2 types of commands, the GP-GL and the HP-GL, that the plotter can use. Match the setting to the used software, or set it to AUTO.

Supplement

- With the AUTO, automatic detection of the command may make mistake depending on the data. It will give error or malfunction when it has made mistake. In that case, set the command before using.
- Always send the data when the plotter is in READY status when the AUTO is set.
- When using data with the AUTO, it will be ready to automatically detect next command 10 seconds after completing the cutting. Send next data after 10 seconds has passed after previous cutting when sending data with different command.

Operation

1. Press the [≡] icon.

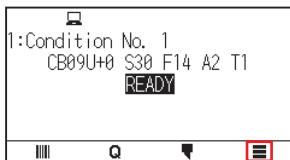

2. Press the [CONFIG].

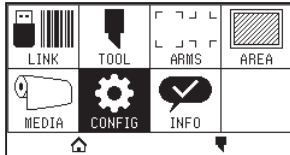

3. Press the [COMMAND].

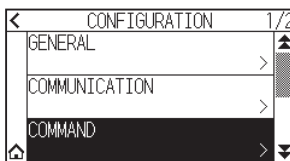

4. Press the [COMMAND TYPE].

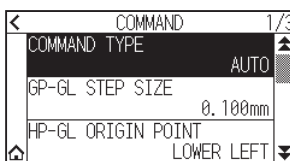

5. Press the command you want to use.

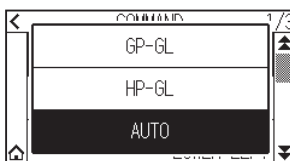

6. Press the [HOME] icon.

▶ It will return to HOME screen.

Priority of cut condition selection

Select the priority of the setting created by different method when the tool condition is set.

All the tool condition that is received from the computer will be ignored, and only the setting and change of the tool condition from the control panel is accepted when “MENU PRIORITY” is selected. This setting set here is maintained even if the power is turned off.

On the other hand, it will set the most current tool condition either from the control panel or from the software when “COMMAND PRIORITY” is selected. The values set from the control panel are maintained, and the values set from the software are erased when the power is turned off.

Operation

1. Press the [≡] icon.



2. Press the [CONFIG].

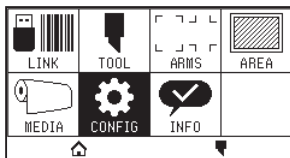

3. Press the [COMMAND].

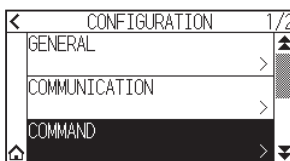

4. Press the [▼] icon twice.

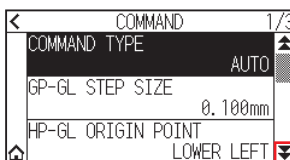

5. Press the [CUT CONDITION].

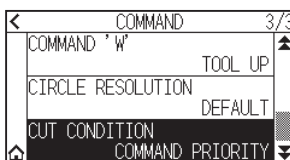

6. Press the setting value you want to use.

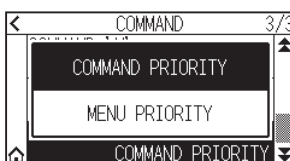

7. Press the [HOME] icon.

▶ It will return to HOME screen.

11.2 Related to GP-GL command

This section is useful only when using the GP-GL command.

Setting the GP-GL step size

The distance to travel with 1 step can be changed. Match the setting value of the application to be used.

Operation

1. Press the [≡] icon.

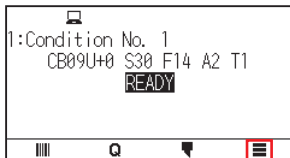

2. Press the [CONFIG].

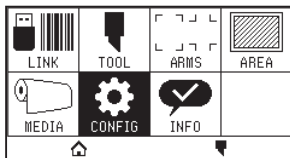

3. Press the [COMMAND].

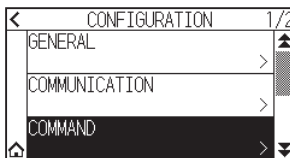

4. Press the [GP-GL STEP SIZE].

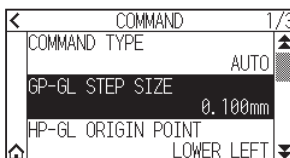

5. Press the setting value you want to use.

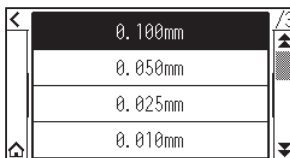

6. Press the [HOME] icon.

▶ It will return to HOME screen.

Enabling/Disabling the ':' and ';' commands

If the first part of the data is lost when the GP-GL command is set, these commands may be having an adverse effect. In this case, set the ':' and ';' commands to DISABLED.

Operation

1. Press the [≡] icon.

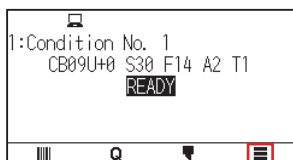

2. Press the [CONFIG].

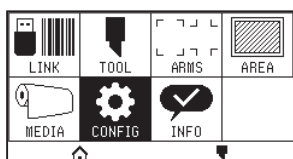

3. Press the [COMMAND].

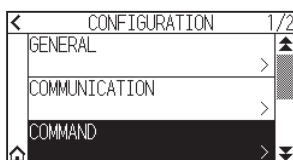

4. Press the [↓] icon.

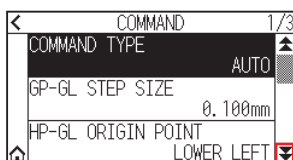

5. Press the [COMMAND ':',';'].]

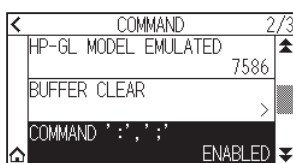

6. Press the setting value you want to use.

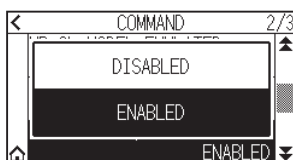

7. Press the [HOME] icon.

▶ It will return to HOME screen.

Moving the pen while raised or lowered in Response to the 'W' command

Here, you can change the settings for the 'W' command, which is a GP-GL arc cutting command. The pen will move to the specified starting position in the raised status when it is set to TOOL UP, regardless of the pen's conditions.

The pen will move without changing its condition, to the specified starting position in the lowered status when it is set to TOOL DOWN.

Supplement

This has an effect on the tool cutter only. For the pen setting, always the pen is raised (PEN UP).

Operation

1. Press the [≡] icon.

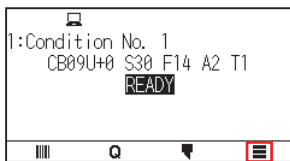

2. Press the [CONFIG].

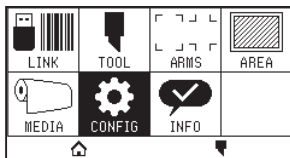

3. Press the [COMMAND].

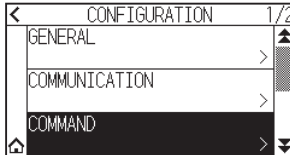

4. Press the [▼] icon twice.

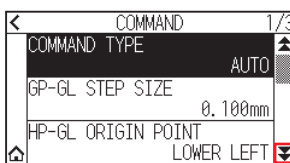

5. Press the [COMMAND 'W'].

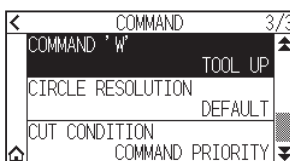

6. Press the setting value you want to use.

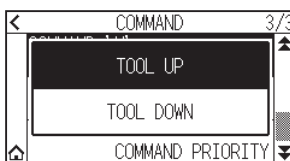

7. Press the [HOME] icon.

▶ It will return to HOME screen.

11.3 Related to HP-GL command

This section is useful only when using the HP-GL command

Model ID response

This function set the operation upon receipt of the "OI" command requesting for the model ID. The reply will be 7550 when set to 7550, and 7586 when set to 7586.

Operation

1. Press the [≡] icon.



2. Press the [CONFIG].

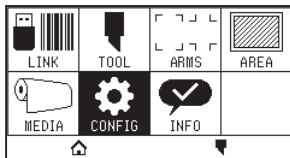

3. Press the [COMMAND].

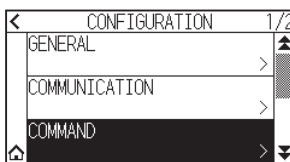

4. Press the [▼] icon.

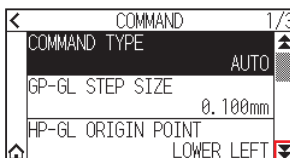

5. Press the [HP-GL MODEL EMULATED].

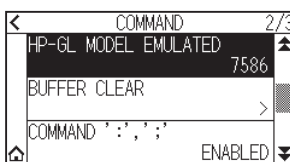

6. Press the setting value you want to use.

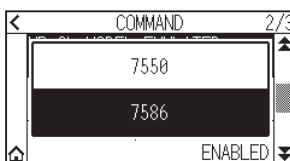

7. Press the [HOME] icon.

▶ It will return to HOME screen.

Circle command resolution

This is a function to set the resolution when receiving the HP-GL command arc cutting command for pen plotter. Select from "AUTO" or "DEFAULT" of 5 degrees.

Operation

1. Press the [≡] icon.



2. Press the [CONFIG].

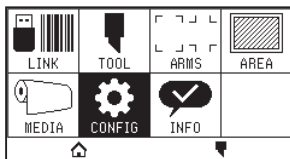

3. Press the [COMMAND].

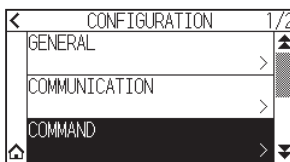

4. Press the [▼] icon twice.

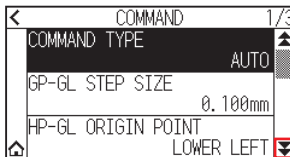

5. Press the [CIRCLE RESOLUTION].

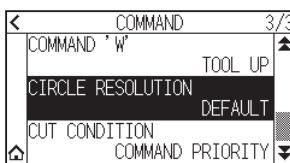

6. Press the setting value you want to use.



7. Press the [HOME] icon.

▶ It will return to HOME screen.

Chapter 12: Data Link

This chapter describes settings regarding the data link.

SECTION IN THIS CHAPTER

12.1 Select Connection Destination

12.2 Data Link with USB Memory

12.3 Output with a Bar Code

12.4 Communication Timeout

12.5 Skew Scanning

12.1 Select Connection Destination

Dedicated data created previously with application software etc. is output to the cutting plotter. It can be saved in USB memory and output the data saved in USB memory, or output via server (personal computer) using network or USB cable.

Operation

1. Press the [≡] icon.



2. Press the [LINK].

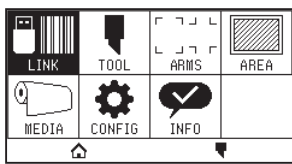

3. Press the [DESTINATION].

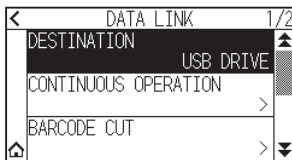

Supplement

- "SERVER (LAN)" is displayed when the wired LAN module is installed.
- "SERVER (WLAN)" is displayed when the wireless LAN module is installed.

4. Press the connection destination you want to use.

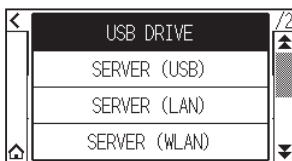

5. Press the [HOME] icon.

▶ It will return to HOME screen.

12.2 Data Link with USB Memory

Dedicated data created previously with application software etc. can be saved in the USB memory and output from the cutting plotter.

Data link can be performed by selecting data from the plotter menu.

Supplement

- File name
 - Only 1-byte alphanumeric characters (ASCII) are supported.
 - Windows prohibited characters (¥, \, /, ;, *, ?, ", <, >, |, etc. are not available.
 - Limit of the number of display characters is 25 characters. More characters than 25 can be displayed by scrolling.
 - Extension is ".xpf" and ".plt".
- Scroll is displayed after a few moments after selecting the item.
- The folder is surrounded by '<' and '>'.
- Name is sorted in ascending order.
- Files and folders can be obtained up to 64.
- Files in the second level folder is not available.
- Practical examples of data links are also included in the separate "Cutting Master 5 User's Manual" and "Graphtec Studio 2 User's Manual". Please refer to it as needed.
- Only FAT32 is supported as the USB memory format. NTFS and exFAT are not supported.

Operation

1. Insert the USB memory that saved the dedicated data to the plotter.
2. Press the  icon.



3. Press the [LINK].

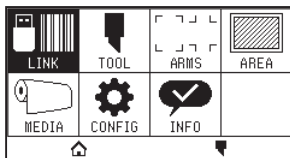

4. Press the [DESTINATION].

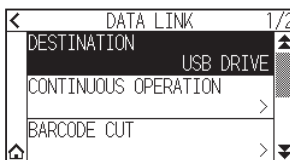

5. Press the [USB DRIVE].

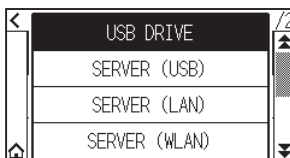

- Press the [▼] icon.

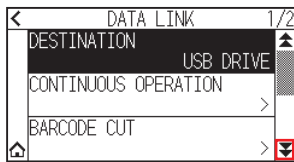

- Press the [SELECTS DATA FILE].

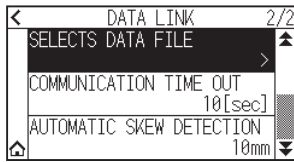

Supplement

- If the USB memory is not inserted, the following is displayed.

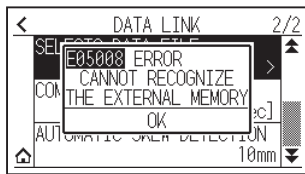

- If there is no data in the USB memory, the following screen is displayed.

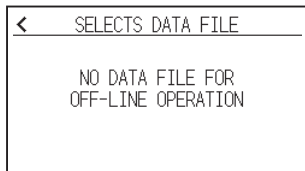

- Use the [▼] and [▲] icons to display the file to be used.



Supplement

The string in parentheses <> is the folder name.
Press the folder name to display the files in the folder.

- Press the file you want to use.

▶ Start cutting with the selected file.

- It will return to READY status when the cutting is completed.

12.3 Output with a Bar Code

The information related to the output file is bar-coded using the Cutting Master 5 and Graphtec Studio 2, etc. and the barcode can be printed with the design and the registration marks.

When cutting with the cutting plotter, the bar code is scanned and the cut data (XPF) that has been saved to a USB memory that matches the bar code is detected.

Continuous operation bar code

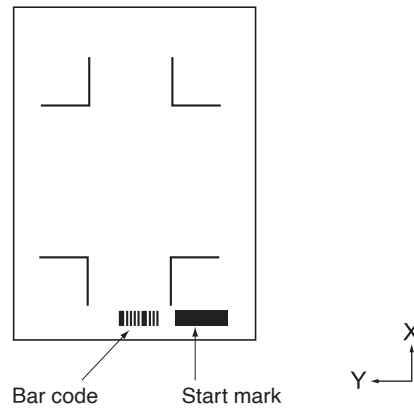

Supplement

Practical examples of data links are included in the "Cutting Master 5 User's Manual" and "Graphtec Studio 2 User's Manual".

Please download each User's Manual from the URL listed in "Chapter 13 Cutting with supplied application software".

Operation

1. Insert the USB memory that saved the dedicated data to the plotter.
2. Press the [≡] icon.

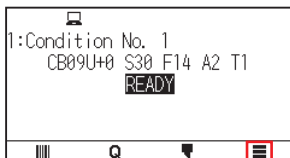

3. Press the [LINK].

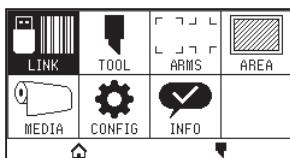

4. Press the [BARCODE CUT].

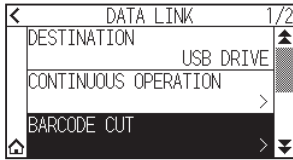

Supplement

- If the USB memory is not inserted, the following is displayed.

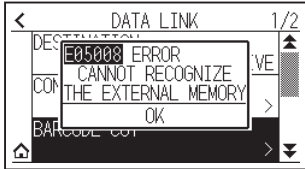

- When the Rotation is set to ON, the following display is displayed.

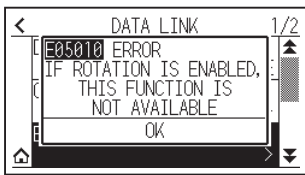

- When the Mirror is set to ON, the following display is displayed.

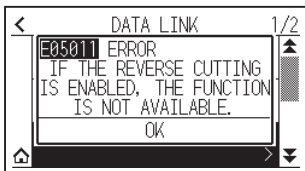

- When the Panel Cutting is set to ON, the following display is displayed.

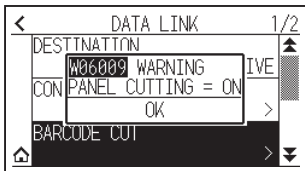

5. Press the POSITION (▲, ▼, ◀, ▶) key to move the tool to the start mark position.

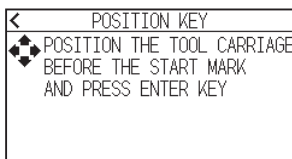

6. Confirm the tool position and press the [ENTER] key.

▶ The bar code is scanned.

Supplement

If the start mark is not scanned, the following display is displayed.
Check the print result of start mark and the scanning start position etc.

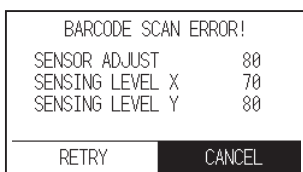

7. Find the file, and then start cutting.



Supplement

- If the appropriate files are found, select the desired file.

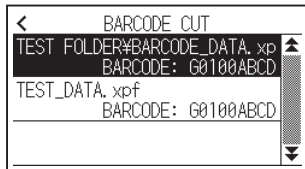

- If the appropriate files is not found, the following screen is displayed.



8. When cutting is completed, it will become READY status.

12.4 Communication Timeout

When the communication is lost during connecting to the data link server, the connection will be canceled after a certain period of time has elapsed.

You can set the time until it is canceled.

Operation

1. Press the [≡] icon.

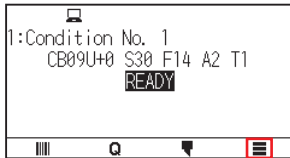

2. Press the [LINK].

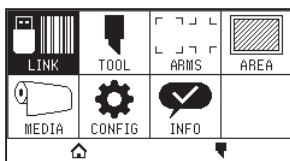

3. Press the [▼] icon.

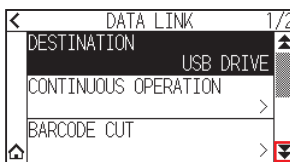

4. Press the [COMMUNICATION TIME OUT].

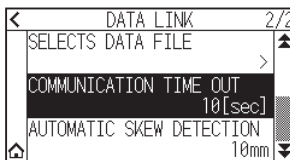

5. Specify the setting value using the [▲] [▼] icon or the [≡] icon.

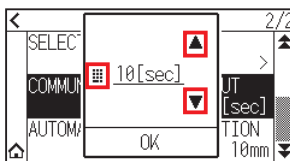

Supplement

You can set the range between 5 and 60 sec.

6. Confirm the setting and press the [OK].
7. Press the [HOME] icon.
▶ It will return to HOME screen.

12.5 Skew Scanning

When continuous operation is performed, it is possible to set how much skew is allowed by detecting media skew by comparing the start mark positions of the start page and the current page.
For continuous operation, see Instruction manual for each application software.

Operation

1. Press the [≡] icon.

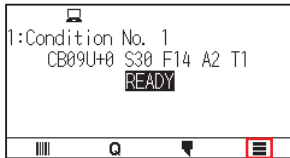

2. Press the [LINK].

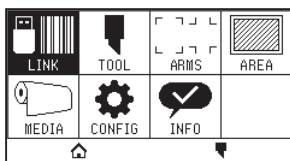

3. Press the [▼] icon.

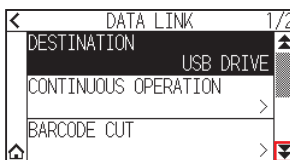

4. Press the [AUTOMATIC SKEW DETECTION].

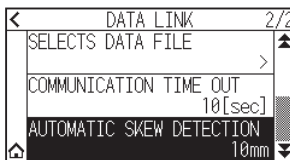

5. Press the setting value you want to use.

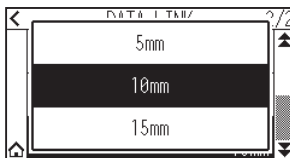

Supplement

When continuous operation is performed, it is possible to set how much skew is allowed by comparing the start mark position on previous page.

6. Press the [HOME] icon.
▶ It will return to HOME screen.

Chapter 13: Cutting with supplied application software

For information on how to cut using application software, refer to the instruction manual for each application software.

Please download the User's Manual for each application software from the URL below.

<http://www.graphteccorp.com/support/software/cuttingplotters.html>



Chapter 14: Maintenance

This chapter describes the settings for the maintenance.

SECTION IN THIS CHAPTER

14.1 Daily Maintenance

14.2 Replacing Cutter Blade

14.3 Cleaning the Cutter Plunger

14.4 Cutter Plunger Exchange

14.5 Setting the Alarm for Blade Wear Alarm

14.1 Daily Maintenance

Daily maintenance

During the course of daily plotter operation, be sure to observe the following precautions:

- (1) Never lubricate the mechanisms of the plotter.
- (2) Clean the plotter's casing using a dry cloth or a cloth that has been moistened in a neutral detergent diluted with water.
Never use thinner, benzene, alcohol, or similar solvents to clean the casings; they will damage the casing's finish.
- (3) Clean the cutting mat using a dry cloth. In case of stubborn stains, use a cloth that has been moistened in alcohol or in a neutral detergent diluted with water.
- (4) If dust or dirt gets on the sensor that detects the media, it may cause malfunction. Clean the plotter's media sensors using a cloth moistened in a neutral detergent diluted with water.
* Never use thinner, benzene, alcohol, or similar solvents to clean the sensors; cleaners such as these will damage the sensors.
- (5) When the Y rail sliding surface gets dirty, gently wipe the dirt away with a clean, dry towel.
* The sliding surface has lubricant on it, so be sure not to wipe all the lubricant off as well.

Storing the plotter

When your plotter is not in use, be sure to observe the following points:

- (1) Remove the tool attached to the tool holder.
- (2) Cover the plotter with a cloth to protect it from dust and dirt.
- (3) Do not store the plotter in direct sunlight or in high temperature and high humidity.
- (4) Please lower the set lever so the push roller is in a risen state.

14.2 Replacing Cutter Blade

Replace the cutter blade by referring to the structure diagram of the cutter plunger.

CAUTION

To avoid bodily injury, handle cutter blades with care.

PHP33-CB09N-HS/PHP33-CB15N-HS

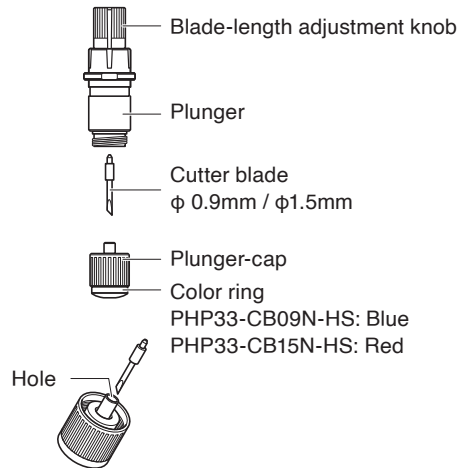

Operation

1. Turn the blade-length adjustment knob in the direction of the B arrow and pull the blade into the plunger.

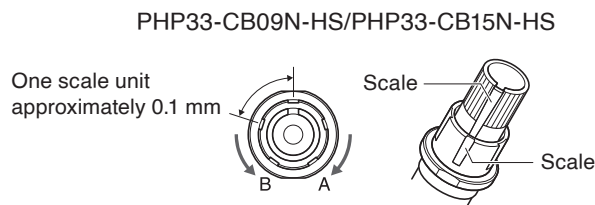

2. Turn the plunger cap in the counter-clockwise direction to remove it from the plunger.
3. Remove the blade from inside the plunger cap.
4. Take a new blade out of its pack. Insert the new blade into the hole provided in the plunger cap.
5. Insert the blade into the plunger cap and attach the plunger from above in that state.
6. Secure the plunger cap by turning it clockwise.

CAUTION

Please fully insert the cutter blade straight into the plunger cap.

If the cutter blade cannot be inserted straight, please insert the cutter blade after pressing the insertion port of the cutter blade several times.

If not installed correctly, it may result in damage to the cutter blade or the plotter itself.

Insertion port of the cutter blade



14.3 Cleaning the Cutter Plunger

Letting leftover media and paper dust build up on blades can dull them and cause them to deteriorate. Be sure to clean the cutter plunger regularly and remove build up.

CAUTION

To avoid bodily injury, handle cutter blades with care.

Cleaning

1. Please clean off paper dust and media powder build up from the blade.
After cleaning it, return it to its proper place.
Spin the plunger cap, remove it, and then clean the blade entrance area.

PHP33-CB09N-HS/PHP33-CB15N-HS

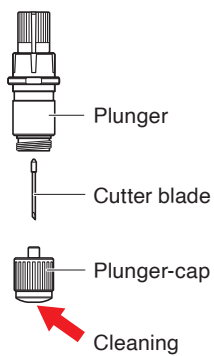

2. After completing cleaning, attach the plunger cap.

14.4 Cutter Plunger Exchange

The tip of the cutter plunger gets worn down due to friction with the media.

When the tip of the cutter plunger gets worn down, cut quality suffers.

When the tip of the plunger cap gets worn down, it is recommended that you exchange the cutter plunger.

PHP33-CB09N-HS/PHP33-CB15N-HS

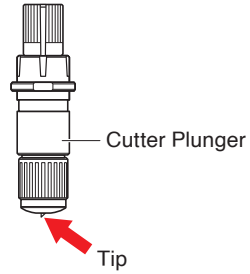

CAUTION

To avoid bodily injury, handle cutter blades with care.

14.5 Setting the Alarm for Blade Wear Alarm

This function allows to measure the cut distance of pen or cutter blade and use it as a guide to determine when the cutter blade should be replaced.

BLADE WEAR DETECT ON/OFF, SET BLADE GROUP, ALARM DISTANCE and BLADE WEAR DETECT settings are required.

Alarm function ON/OFF, group, alarm distance settings

Operation

1. Press the [≡] icon.



2. Press the [TOOL].

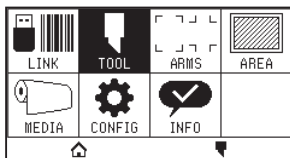

3. Press the [BLADE WEAR ALARM SETUP].

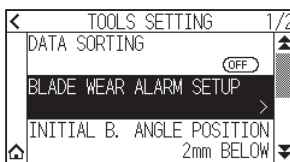

4. Press [BLADE WEAR DETECT.] to turn it to [ON].
To cancel, set it to [OFF].

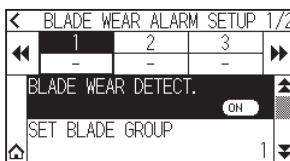

5. Press the [SET BLADE GROUP].

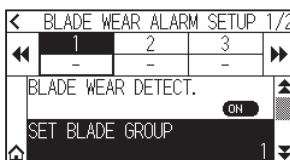

6. Press the group number you want to assign for each tool condition number (1 to 8).

SET BLADE GROUP								
	1	2	3	4	5	6	7	8
G1	✓							
G2		✓						
G3			✓					

Supplement

- The horizontal axis represents the tool condition number (1 to 8) to be set. The vertical axis represents the group number.
- [✓] will be displayed at the assigned location.

7. Press the [←] icon.

SET BLADE GROUP								
	1	2	3	4	5	6	7	8
G1		✓						
G2			✓					
G3				✓				

8. Press the [YES].

SET BLADE GROUP								
DO YOU WANT TO SAVE THE SETTINGS?								
YES				NO				

9. Press the [↓] icon.

BLADE WEAR ALARM SETUP 1/2			
1	2	3	
-	-	-	
BLADE WEAR DETECT. ON			
SET BLADE GROUP			
			1

10. Use the [←←] and [→→] icons to display the group for which you want to set the alarm distance.

BLADE WEAR ALARM SETUP 2/2			
1	2	3	
4000	4000	4000	
ALARM DISTANCE 4000m			
CLEAR B. WEAR VALUE 25%			

11. Press the group you want to set.

BLADE WEAR ALARM SETUP 2/2			
1	2	3	
4000	4000	4000	
ALARM DISTANCE 4000m			
CLEAR B. WEAR VALUE 25%			

12. Press the [ALARM DISTANCE].

BLADE WEAR ALARM SETUP 2/2			
1	2	3	
4000	4000	4000	
ALARM DISTANCE 4000m			
CLEAR B. WEAR VALUE 25%			

13. Specify the setting value using the [▲] [▼] icon or the [≡] icon.

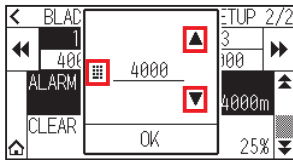

Supplement

You can set the range between 500 m and 100000 m (100 m step).

14. Confirm the setting and press the [OK].
15. Press the [HOME] icon.
▶ It will return to HOME screen.

Blade wear clear setting

Operation

1. Press the [≡] icon.

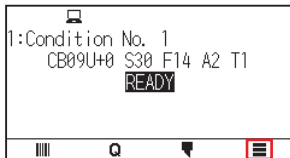

2. Press the [TOOL].

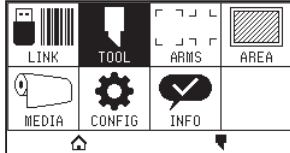

3. Press the [BLADE WEAR ALARM SETUP].

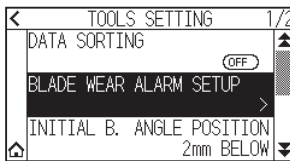

4. Press the [▼] icon.

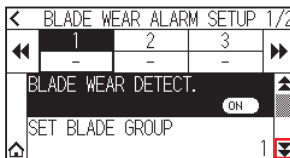

5. Use the [◀] and [▶] icons to display the group whose blade wear you want to clear.

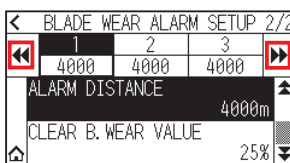

6. Press the group you want to set.

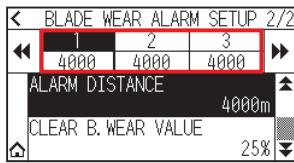

7. Press the [CLEAR B. WEAR VALUE].

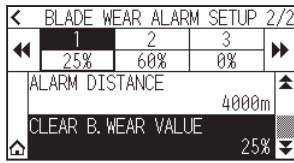

8. Press the [YES].

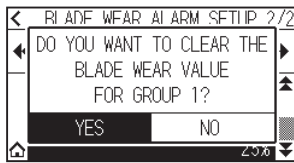

15. Press the [] icon.
▶ It will return to HOME screen.

Chapter 15: Troubleshooting

Refer to this chapter if you feel something is wrong, or it does not work right.

It also describes the settings of the plotter, confirming the cutting data, and method to create test patterns.

SECTION IN THIS CHAPTER

- 15.1 Troubleshooting*
- 15.2 Check plotter information*
- 15.3 Printing the Setting of the Plotter*
- 15.4 Creating Test Pattern*
- 15.5 Creating CUTTING PRO*
- 15.6 Confirm the Plotting Data*
- 15.7 Self Diagnostic Test*
- 15.8 Reading the error message*

15.1 Troubleshooting

When the plotter does not operate after turning the power on

Symptom	Possible Cause	Solution
<ul style="list-style-type: none">Nothing is displayed on the LCD panel.	There is no power supplied. Or, the plotter is defective.	Check that the power cord is securely connected to the plotter's AC line inlet and the electrical outlet. Check that the power is supplied to the electrical outlet. Contact your Graphtec customer center if the problem still exists.
<ul style="list-style-type: none">"Sum-Ck ROM RAM ERR!!" is displayed on the LCD panel.	The ROM or RAM is defective.	Contact your Graphtec customer center if the problem still exists.

When it does not work right

Symptom	Possible Cause	Solution	Reference
<ul style="list-style-type: none"> Drops the media while detecting. 	Bright light might be shining onto the media sensor.	Block the light if there is direct sunlight shining on the plotter that is placed near the window. Move away the fluorescent lamps if there is one close to the plotter.	
	Media sensor may be defective.	Contact your sales representative or the Graphtec call center. Set the media sensor to DISABLED to use the plotter temporarily.	Enabling/Disabling the Media Sensors (MEDIA SENSOR)
<ul style="list-style-type: none"> Media wobbles. 	Push rollers are not set correctly on the grit rollers.	Check the position of the push rollers.	Loading Media (Paper or Marking Film)
	Changing of the hold-down force of the push roller is not suitable for the media. (CE8000-130 only)	Please set a media suitable for changing the hold-down force.	Changing the Hold-down Force
<ul style="list-style-type: none"> Tool carriage hits the left side of the plotter and "POSITION ALARM" is displayed after selecting the media type. Or, it hits the right side of the plotter and "POSITION ALARM" is displayed. 	Push roller sensor may be defective if it hits the left side of the plotter. Home sensor may be defective if it hits the right side of the plotter.	Contact your sales representative or the Graphtec call center. Set the push roller sensor to DISABLED to use the plotter temporarily.	Enabling/Disabling the Push Roller Sensors
<ul style="list-style-type: none"> The plotter stops with "POSITION ALARM" displayed during initialization or cutting. 	CONDITION setting for the media is invalid.	Slow down the speed or lower the FORCE.	Setting the Tool Condition
	The pen carriage does not move by hitting something.	Move the object disturbing the operation, and turn on the plotter after turning it off once.	
	External force is applied to the pen carriage while cutting.	Move the object disturbing the operation, and turn on the plotter after turning it off once.	
	Movement is disturbed by the media chaff in the operation area.	Move the object disturbing the operation, and turn on the plotter after turning it off once.	
<ul style="list-style-type: none"> The plotter is defective. 	Contact your sales representative or the Graphtec call center.		
	Data created with lower left origin point is received when the plotter is set with center origin point. (With HP-GL command)	Reset the origin point to center on the application software, or reset the origin point of the plotter to lower left.	Setting Origin Point When HPGL is Set
	Selected wrong type of the media.	Check the type of media, "SHEET", "ROLL-1 FRONT EDGE", or "ROLL-2 CURRENT POSITION".	Setting Feeding Method
	Data sent to the plotter is not correct.	Check the data.	Error Message in GP-GL Command Mode Error Message in HP-GL Command Mode
<ul style="list-style-type: none"> It cannot cut above certain length. 	Length of the cut is exceeding the length of the page set on the plotter.	Press the [SLOW] key and check the cutting area. Match the setting for the page length.	Setting Length of the Page
<ul style="list-style-type: none"> There are too many tool up and down. 	Setting for the tangential mode is set to ON.	Turn OFF the setting for the tangential mode unless you are cutting thick media.	Setting the TANGENTIAL MODE
<ul style="list-style-type: none"> It is cutting on the grit roller imprint. 	Cutting width is widened.	Please turn OFF the expand setting.	Setting Cutting Width
<ul style="list-style-type: none"> Cannot change the tool condition. 	Setting for the sorting is set to ON.	Normally, use the plotter with setting for the sorting OFF.	Sorting the Cutting Data

Symptom	Possible Cause	Solution	Reference
<ul style="list-style-type: none"> • Tool condition changes. 	Setting of the priority is set to COMMAND PRIORITY.	Change the setting of the priority to MENU PRIORITY.	Priority of Cut Condition Selection.
	[ENTER] key is not pressed after changing the TOOL CONDITION.	Check the TOOL CONDITION again.	Setting the Tool Condition
<ul style="list-style-type: none"> • Media travels tilted. 	Media is loaded tilted.	Reload the media.	Loading Media (Paper or Making Film)
	Media is slipping.	Perform pre feed once and make impression to make it harder to slip.	Pre Feed of Media (Paper or Marking Film)
	Changing of the hold-down force of the push roller is not suitable for the media.	Please set a media suitable for changing the hold-down force.	Changing the Hold-down Force
<ul style="list-style-type: none"> • It does not become specified length. (Slight distance error) 	Media is slipping.	Make the speed slower. Reduce the moving speed. Perform feeding.	Setting the Tool Condition. Pre Feed of Media (Paper or Marking Film) Setting the Tool Up Speed
	Distance adjust value is not correct.	Perform distance adjust.	Setting the Distance Adjust
<ul style="list-style-type: none"> • "LOAD MEDIA!" is displayed even if the media is set and media set lever is moved up. 	Media is close to transparent and media sensor makes false recognition. (This may happen depending on the media.)	Transparent media cannot be detected. DISABLE the media sensor and set the cutting area when this kind of media is used.	Enabling/Disabling the Media Sensors Setting Cutting Area
	Media sensor malfunctions with strong scattered reflection.	Move the position of the light source. Make is so no direct sunlight shines.	
	There may be defective in the operation of the media set lever sensor.	Contact your sales representative or the Graphtec call center.	
<ul style="list-style-type: none"> • Touch panel does not respond. 	The touch panel installed on this plotter is a capacitive type. Insulated touch pens (pressure-sensitive) will not respond.	Use your finger or a capacitive touch pen.	
<ul style="list-style-type: none"> • Wireless LAN access point cannot be found. 	The wireless LAN compatible standard of this plotter is 802.11b/g/n (2.4GHz). It does not support the 5GHz frequency.	Please use an access point that supports the wireless LAN compatible standard 802.11b/g/n (2.4GHz).	

When the Cutting Result is Not Good

Symptom	Possible Cause	Solution
<ul style="list-style-type: none"> • Corners are rounded. • Corners are too sharp. 	Blade and OFFSET does not match.	Change the OFFSET. → It is rounded: Increase the OFFSET → It is too sharp: Decrease the OFFSET
<ul style="list-style-type: none"> • The cut line starts out crooked. 	The blade inside the plunger doesn't turn smoothly.	Remove dirt from inside the plunger.
<ul style="list-style-type: none"> • The blade skips and does not completely cut lines that should be solid. • Straight cut lines seems to wobble. 	The blade is extended too far.	Adjust the blade length.
	The cutting speed is too high.	Lower the speed setting.
<ul style="list-style-type: none"> • Coarse resolution of curved lines. 	The software's resolution setting is too low.	Adjust the software's resolution setting.
	The blade offset angle is too low.	Increase the value for the blade offset angle.
<ul style="list-style-type: none"> • The media curls up at the corners. • Fine cut characters peels off. 	The blade is extended too far.	Adjust the blade length.
	Blade and OFFSET does not match.	Change the OFFSET.
	The cutting speed is too high.	Lower the speed setting.
	The blade is dull.	Replace the blade.
	The ACCELERATION setting is too high.	Lower the ACCELERATION setting.
<ul style="list-style-type: none"> • The blade is cutting into the backing sheet. 	The blade is extended too far.	Adjust the blade length.
	The cutting FORCE is too high.	Lower the FORCE setting.
<ul style="list-style-type: none"> • The blade falls out of the tool plunger. 	The blade is too small for the tool plunger.	Use a blade that fits securely in the tool plunger.
<ul style="list-style-type: none"> • Media can be cut but it is hard to weed afterwards. • Cut media cannot be pulled up using retack sheet. 	The retack sheet is not sticky enough.	Switch to a stickier retack sheet.
	Media gets entangled during cutting.	Reduce the blade length.
		Lower the FORCE setting.
	Cleaning of cut media was postponed too long.	Promptly weed cut media.
<ul style="list-style-type: none"> • Abnormal noise generated from the tool carriage during cutting. • The media is discolored where the blade has passed. 	Media is rubbed by the tip of the tool plunger.	Adjust the blade length and the cutting FORCE settings.
	<ul style="list-style-type: none"> • The cutting results differ from the specified size. 	The STEP SIZE has been set differently at the computer and the plotter.
<ul style="list-style-type: none"> • Currently selected cutting conditions are disregarded or cannot be changed. 	Scaling has been specified on the computer.	Check whether scaling has been specified.
	Setting of the priority is set to COMMAND PRIORITY.	Change the setting of the priority to MENU PRIORITY.
<ul style="list-style-type: none"> • Characters or lines are deformed during pen plotting. 	The [ENTER] key was not pressed after changing the settings.	Check the operation.
	The plotter is in cutting mode.	Select PEN as the tool in the CONDITION setting.
<ul style="list-style-type: none"> • It does not become specified length. (Slight distance error) 	Distance adjust value is not correct.	Perform distance adjust.
<ul style="list-style-type: none"> • Characters are deformed. • Complex drawings are deformed. 	The STEP PASS setting is set too high.	Lower the STEP PASS setting.
	<ul style="list-style-type: none"> • The starting and end points of cutting do not match. 	Coordinate points are incorrectly specified.
	The media backing is too flimsy.	Switch to a media with a stronger backing.
	Blade rotation is not smooth.	Check that there is no dirt in the blade.

Error Messages in GP-GL Command Mode

Error Displayed	LCD Display	Cause	Solution
E02001		The plotter received an unrecognizable command.	Press the [ENTER] key.
		Noise came in when the computer was turned on.	Configure to drive the plotter from the menu of the software.
		The software configuration regarding the output device has been changed.	Reset the interface settings of the software.
		The plotter's interface conditions have changed.	Reset the interface settings of the plotter.
E02004		A command was received containing numeric parameters that exceed that command's permissible range.	Configure to drive the plotter from the menu of the software.
		The software configuration regarding the output device has been changed.	Reset the interface settings of the software.
		The plotter's interface conditions have changed.	Reset the interface settings of the plotter.
E02005		An error occurred in the receipt of data within the interface.	Configure to drive the plotter from the menu of the software.
		The software configuration regarding the output device has been changed.	Reset the interface settings of the software.
		The plotter's interface conditions have changed.	Reset the interface settings of the plotter.
E02006		The data out of cutting range has been received.	Check the data.
			Check the size of media and the cutting range.
			Check the magnification setting.
			Check the step size settings.

Error Messages in HP-GL Command Mode

If any of the following command errors occur, they are nearly always caused by following 2 reasons.

- (1) The configuration regarding the output device in the application software has changed.
- (2) The plotter's interface conditions have changed.







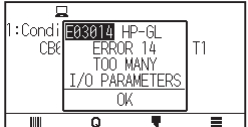

Perform following if these are the cause of the problem.

- (1) Reconfigure the output device of the application software to the plotter.
- (2) Reconfigure the plotter's interface conditions.

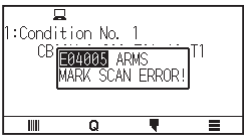
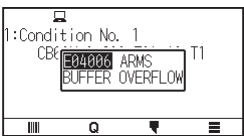
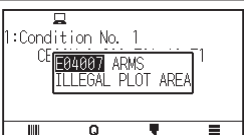
Error Displayed	LCD Display	Cause	Solution
E03001 Error 1		An unrecognizable instruction was executed.	Execute a recognizable command.
E03002 Error 2		Wrong number of parameters were specified.	Execute the command with the correct number of parameters.
E03003 Error 3		An unusable parameter was executed.	Execute a recognizable parameter.
E03005 Error 5		An unusable character set was specified.	Specify usable character set.
E03006 Error 6		Coordinates of command specified out of cutting area.	Execute coordinates within the cutting area.
E03007 Error 7		The data being input exceeds the capacity of the plotter's downloadable character buffer, polygon buffer, etc.	Adjust the buffer size.
E03010 Error 10		Other output command was executed while executing an output command.	Check the program.
E03011 Error 11		An invalid byte was received after ESC code.	Check the program.
E03012 Error 12		Invalid byte was received within device control command.	Check the program.
E03013 Error 13		A parameter outside of the permissible range was specified in the I/O related command.	Check the program.

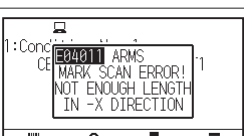

Error Displayed	LCD Display	Cause	Solution
E03014 Error 14		Too many parameters in the I/O related command.	Check the program.

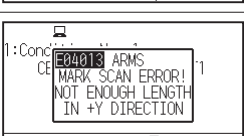
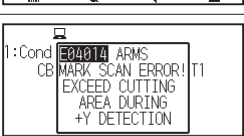

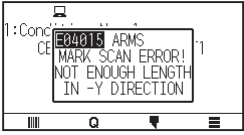
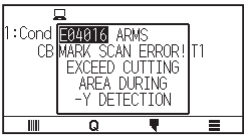
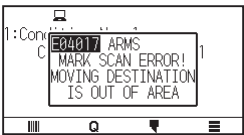
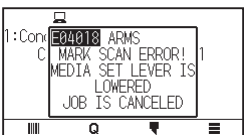
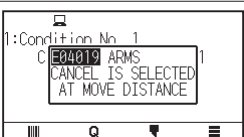
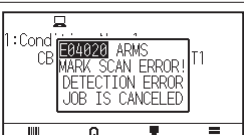
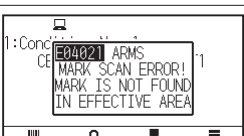
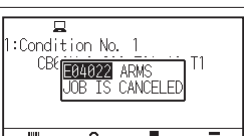
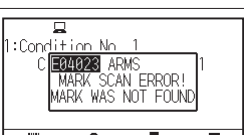
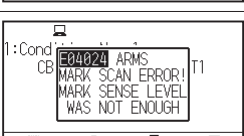
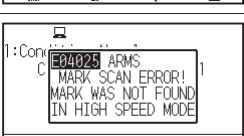

ARMS Error Messages

Error Displayed	LCD Display	Cause	Solution
E04001		Tilt to adjust with AXIS ALIGNMENT is too large.	Reload the media.
E04004		It is over the setting range of the distance adjust.	Reset to smaller value.
E04005		Could not scan the registration marks.	Check the registration scan position.
E04006		Amount of data has exceeded the I/O buffer size for the segment area registration mark.	Decrease the data.
E04007		Test pattern plotting position is not within the plotting area for sensor position adjustment.	Move the media toward center and plot the test pattern.
E04008		Media end was detected while detecting the registration mark.	Check the media. Check the print position of the registration mark.
E04009		It has exceeded detection area while detecting the registration mark.	Check the media. Check the print position of the registration mark.
E04010		It has exceeded detection area while detecting the registration mark.	Check the media. Check the print position of the registration mark.
E04011		It has exceeded detection area while detecting the registration mark.	Check the media. Check the print position of the registration mark.
E04012		It has exceeded detection area while detecting the registration mark.	Check the media. Check the print position of the registration mark.
E04013		It has exceeded detection area while detecting the registration mark.	Check the media. Check the print position of the registration mark.
E04014		It has exceeded detection area while detecting the registration mark.	Check the media. Check the print position of the registration mark.

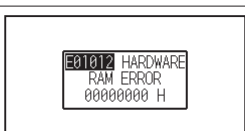

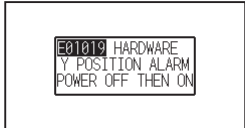

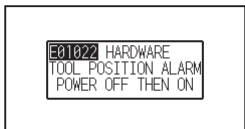
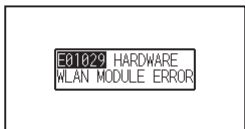
Error Displayed	LCD Display	Cause	Solution
E04015		It has exceeded detection area while detecting the registration mark.	Check the media. Check the print position of the registration mark.
E04016		It has exceeded detection area while detecting the registration mark.	Check the media. Check the print position of the registration mark.
E04017		It has exceeded detection area while detecting the registration mark.	Check the media. Check the print position of the registration mark.
E04018		Media set lever was lowered.	Reload the media and try again.
E04019		There was cancel operation by the user.	Redo the process.
E04020		There is a defect in the detection settings value.	Check the settings value.
E04021		Registration mark was not detected in the auto detection area.	Check the media. Check the print position of the registration mark.
E04022		There was cancel operation by the user.	Redo the process.
E04023		Registration mark was not detected.	Change the color of the registration mark. Check the media. Check the print position of the registration mark.
E04024		Registration mark was not detected.	Change the color of the registration mark. Check the media. Check the print position of the registration mark.
E04025		Registration mark was not detected.	Change the color of the registration mark. Check the media. Check the print position of the registration mark.

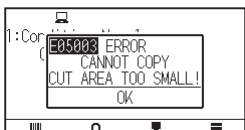
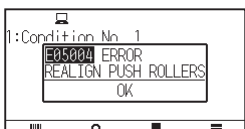
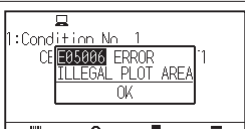
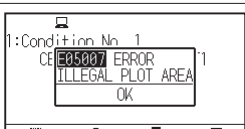
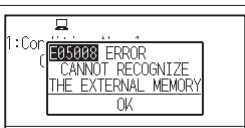
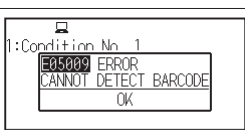
Other Error Messages

Error Displayed	LCD Display	Cause	Solution
E01001 to E01005		The plotter is defective.	Contact your sales representative or the Graphtec call center.
E01006		The plotter is defective.	Contact your sales representative or the Graphtec call center.
E01007		The plotter is defective.	Contact your sales representative or the Graphtec call center.
E01008		The plotter is defective.	Contact your sales representative or the Graphtec call center.
E01009		The plotter is defective.	Contact your sales representative or the Graphtec call center.
E01010		The plotter is defective.	Contact your sales representative or the Graphtec call center.
E01011		The plotter is defective.	Contact your sales representative or the Graphtec call center.
E01012		The plotter is defective.	Contact your sales representative or the Graphtec call center.
E01013		The plotter is defective.	Contact your sales representative or the Graphtec call center.
E01014		The plotter is defective.	Contact your sales representative or the Graphtec call center.
E01015		The plotter is defective.	Contact your sales representative or the Graphtec call center.
E01017		Load on the motor was too large.	Move the object disturbing the operation, and turn on the plotter after turning it off once. Do not use heavy media. Contact your sales representative or the Graphtec call center if the error still appears.

Error Displayed	LCD Display	Cause	Solution
E01019		Load on the motor was too large.	Move the object disturbing the operation, and turn on the plotter after turning it off once. Do not use heavy media. Contact your sales representative or the Graphtec call center if the error still appears.
E01021		Load on the motor was too large.	Move the object disturbing the operation, and turn on the plotter after turning it off once. Do not use heavy media. Contact your sales representative or the Graphtec call center if the error still appears.
E01022		There was a heavy load on the up and down function of the tool carriage.	Please clear any obstruction in the up and down function of the tool carriage and turn the power back on. Contact your sales representative or the Graphtec call center if the error still appears.
E01029		An error has occurred in the wireless LAN module.	Turn the power off and then on again. Contact your sales representative or the Graphtec call center if the error still appears.
E05001		Data larger than the buffer size cannot be copied.	Perform normal cutting not using the copy mode.
E05002		There is no data to copy.	Perform normal cutting by sending the data, then use the copy mode.
E05003		Media valid area to copy is too small.	Use larger media. Confirm the copy start position.
E05004		The push roller is not on the grit roller.	Set the push roller on the grit roller.
E05006		Distance between the bottom left and top right of the AREA setting is less than 10 mm.	Perform the AREA setting again.
E05007		Test pattern for the TOOL OFFSET ADJ. cannot start plotting because the start position is at the edge of the media.	Set the start position inside the media.
E05008		External memory (USB memory) cannot be recognized.	Insert external memory (USB memory).
E05009		Bar Code cannot be scanned.	Check the print result of Bar Code.

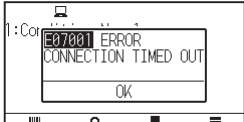
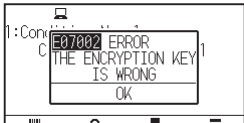
Error Displayed	LCD Display	Cause	Solution
E05010		Bar Code cutting is not available when Rotation is set to ON.	Set Rotation is set to OFF to use Bar Code cutting.
E05011		Bar Code cutting is not available when Mirror is set to ON.	Set Mirror is set to OFF to use Bar Code cutting.
E05012		The desired file cannot be found in external memory (USB memory).	Save the desired file in external memory (USB memory).
E05013		Start mark cannot be scanned.	Check the print result of start mark. Move the tool carriage above the start mark.
E05014		The selected connection destination cannot be found.	Connect to the selected connection destination using USB or LAN cable.
E05015		There is no appropriate cutting data for the data link server.	Check the data link server.
E05016		The communication to the data link server is not established.	Check the data link server. Increase the time until the timeout.
E05017		Media set lever is lowered.	Set the media again.
E05018		A trouble occurs in the data link server.	Restart the data link server.
E05019		A trouble occurs in communication to the data link server.	Set the media again. Turn the power off and then on again.
E05020		The connection destination is not USB memory.	Set connection destination to USB memory.
E05021		The type of bar code is different.	Apply the appropriate bar code.

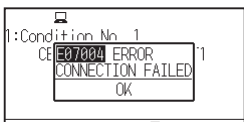
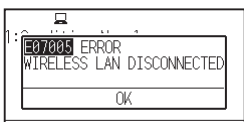
Error Displayed	LCD Display	Cause	Solution
E05022		Media skew is detected.	Set the media again. Increase the skew detection set value.
E05023		Data link server is not activated.	Activate data link server.
E07001		Communication with the access point is no longer possible.	Please check the communication status with the access point.
E07002		The encryption key of access point is incorrect.	Please enter the correct encryption key of access point.
E07003		No access point was found to connect to.	Make sure there is an access point nearby and that the access point is turned on.
E07004		Access point connection failed.	Check the operating status of the access point.
E07005		Communication with the access point has been disconnected.	Check the operating status of the access point.

Caution Message

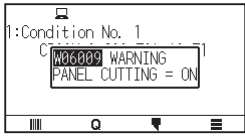
Symptom	LCD Display	Description
W06008		When command is set to AUTO, the DUMP mode is not available.
W06009		When panel cutting has been set to ON, the following functions are not available. <ul style="list-style-type: none"> • ARMS function • AREA function • COPY function • BARCODE CUT function • CONTINUOUS OPERATION function

15.2 Check plotter information

Displays information such as the firmware version and serial number of the plotter.

Operation

1. Press the [≡] icon.



2. Press the [INFO].

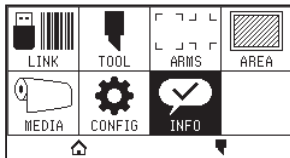

3. Press the [MACHINE INFORMATION].

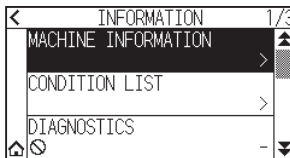

4. Information about the machine is displayed.

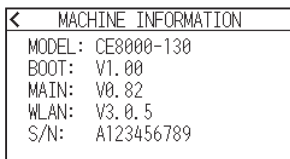

5. Press the [←] icon.

6. Press the [HOME] icon.

▶ It will return to HOME screen.

15.3 Printing the Setting of the Plotter

Condition setting list can be printed when you need to check the current setting of the plotter.

Operation

1. Load a media larger than A3 size.
2. Set the pen tool to the tool holder (Backward) and select the condition where the pen tool is set.
3. Press the [≡] icon.

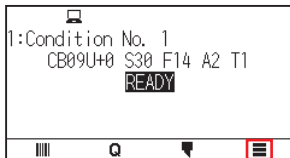

4. Press the [INFO].

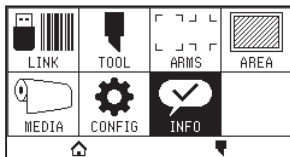

5. Press the [CONDITION LIST].

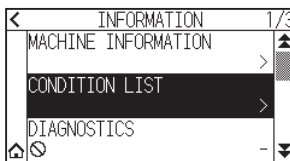

6. Press the [1/2 PAGE] or [2/2 PAGE].

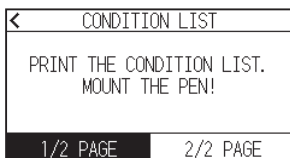

7. Press the POSITION (▲, ▼, ◀, ▶) key to move the tool to the print start position.

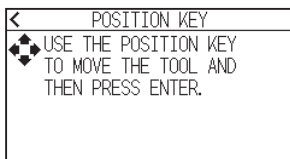

8. Press the [ENTER] key.

⚠ CAUTION

Do not place your hand around the moving areas. The tool carriage will start moving, so there is a chance of injury.

9. Printing of the condition list will start.

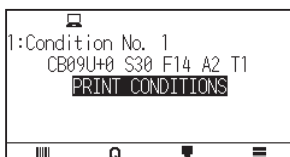

10. It will return to READY status when the printing is completed.

Supplement 

Once printing starts, it cannot be paused or canceled midway.

15.4 Creating Test Pattern

Create a self-test pattern to check the operation of the plotter.

Operation

1. Load a media larger than A3 size.
2. Set the pen tool to the tool holder (Backward) and select the condition where the pen tool is set.
3. Press the [≡] icon.



4. Press the [INFO].

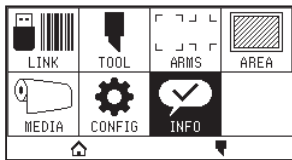

5. Press the [▼] icon.

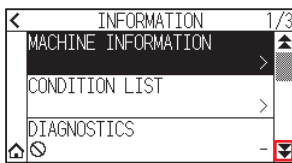

6. Press the [SELF TEST].

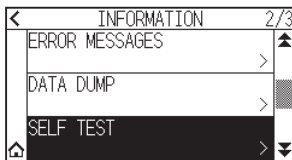

7. Press the [START].

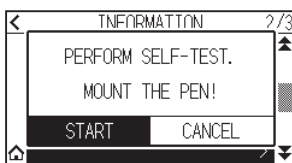

CAUTION

Do not place your hand around the moving areas. The tool carriage will start moving, so there is a chance of injury.

8. The self-test will start.

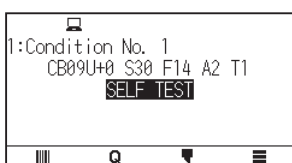

9. To exit, turn off the power.

Supplement 

Once the self-test starts, it will continue to run until you turn off the power.

15.5 Creating CUTTING PRO

Create a test pattern to check the operation of the plotter.

Operation

1. Load a media larger than A3 size.
2. Select the conditions that comply with the set tool.
3. Press the [≡] icon.

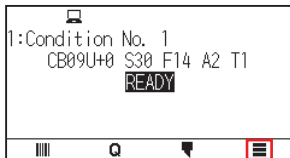

4. Press the [INFO].

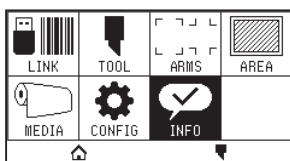

5. Press the [▼] icon twice.

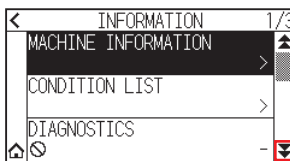

6. Press the [CUTTING PRO].

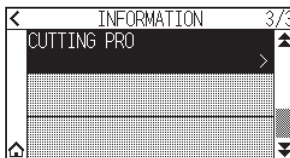

7. Press the [START].

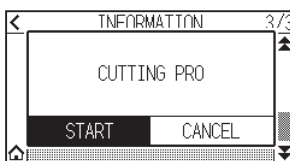

CAUTION

Do not place your hand around the moving areas. The tool carriage will start moving, so there is a chance of injury.

8. "CUTTING PRO" plotting will start.
9. It will return to READY status when the cutting is completed.

15.6 Confirm the Plotting Data

Output of the dump list of the cutting data received by the plotter is possible. It is used to check if the transmission of cutting data is performed correctly.

Supplement

If the command setting is "Auto", the dump list of the cutting data is not output.
Please set the command to "GP-GL" or "HP-GL".

Operation

1. Load a media larger than A4 size.
2. Set the pen tool to the tool holder (Backward) and select the condition where the pen tool is set.
3. Press the  icon.



4. Press the [INFO].

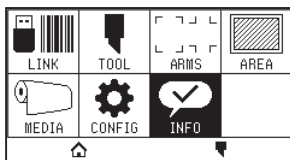

5. Press the  icon twice.

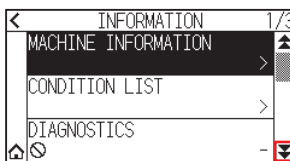

6. Press the [DATA DUMP].

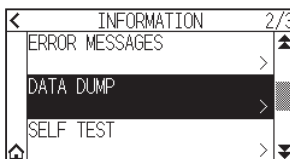

7. Press the [START].

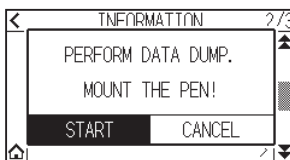

8. Send the cutting data.

CAUTION

Do not place your hand around the moving areas. The tool carriage will start moving, so there is a chance of injury.

9. Outputs the received cutting data as a command.

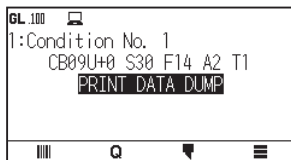

10. To exit, turn off the power.

15.7 Self Diagnostic Test

Operation status can be tested by self-diagnostic test by operating the sensors and switches following the instruction on the screen.

Supplement

Diagnostic test can be performed only right after the power is turned on. DIAGNOSTICS cannot be selected from the menu once any operation, such as loading media, is performed.

Operation

1. Confirm that the power is turned off.
2. Turn the power on without loading the media.
3. Press the [≡] icon.



4. Press the [INFO].

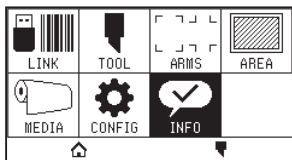

5. Press the [DIAGNOSTICS].

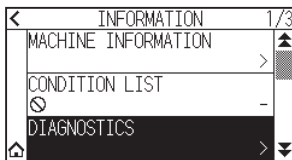

6. Press the [START].

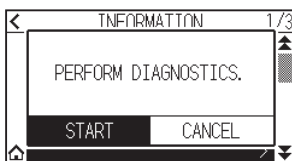

7. Operate the keys and the sensors following the instructions on the screen.
 - ▶ "OK" will be displayed if the correct operation is detected as a result of the operation, and next test will start.
 - ▶ It will return to the screen shown in step 4 once all the test items are completed.

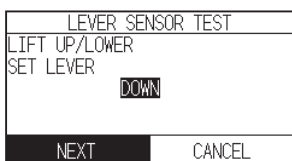

Test items are as following. (It may be changed.)

1	Set lever sensor	2	Home sensor	3	Push roller sensor	4	-X media sensor
5	+X media sensor	6	X motor signal	7	Y motor signal	8	Tool height signal
9	[SLOW] key	10	POSITION [▲] key	11	POSITION [◀] key	12	POSITION [▼] key
13	POSITION [▶] key	14	[ESCAPE] key	15	[ENTER] key		

8. Press the [] icon.

▶ It will return to HOME screen.

15.8 Reading the error message

Contents of most current 32 errors can be checked.

Operation

1. Press the [≡] icon.



2. Press the [INFO].

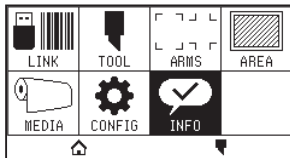

3. Press the [▼] icon.

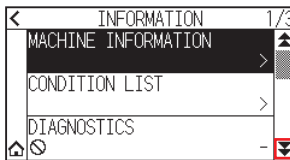

4. Press the [ERROR MESSAGES].

▶ ERROR MESSAGES screen is displayed. Left column is time the error occurred, and right column is the type of the error. 3 error messages are displayed at once. If there are more error messages, next 3 messages will be displayed by pressing the [▼] icon.

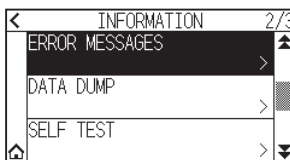

Supplement

- "NO ERROR" will be displayed if there is no error.



- Up to 32 error messages can be displayed.
- When displayed, while the power is on it indicates how long ago an error occurred. The lower the value, the more recently the error occurred.

5. Press the error item for which you want to check the error details.

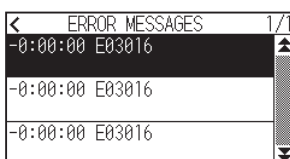

6. Check the error message and press the [OK].

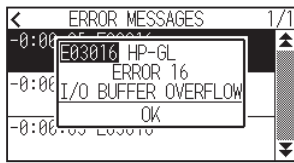

7. Press the [←] icon.
8. Press the [🏠] icon.
▶ It will return to HOME screen.

Appendix

This chapter describes the specification of the plotter.

SECTION IN THIS CHAPTER

- A.1 Main Specifications*
- A.2 Options and Supplies*
- A.3 External Dimensions*
- A.4 Menu Tree*
- A.5 Initial Setting*

A.1 Main Specifications

	CE8000-40	CE8000-60	CE8000-130
CPU	32bit CPU		
Configuration	Grit-rolling plotter		
Drive	Digital servo		
Max. Cutting Area	375 mm× 50 m	603 mm×50 m	1270 mm×50 m
Guaranteed precision cutting area *1	355 mm× 2 m	583 mm×2 m 583 mm× 5 m *2	1250 mm×2 m 1250 mm×5 m *2
Available media width	Min: 50 mm Max: 484 mm (19 inch)	Min: 50 mm Max: 712 mm (28 inch)	Min: 85 mm Max: 137 2mm (54 inch)
Available roll media diameter	Max. diameter: 180 mm, Min. diameter: 76 mm		
Media weight that can be loaded	5 kg	9 kg	17 kg
The number of push rollers	2		3
Max. cutting speed	90 cm/s (45°direction)		100 cm/s (45°direction)
Specifiable speeds (cm/s)	1 to 10, 15, 20, 25, 30, 35, 40, 45, 50, 55, 60, 64		1 to 10, 15, 20, 25, 30, 35, 40, 45, 50, 55, 60, 65, 70, 71
Max. cutting force	4.41N (450gf)		
Min. character size	5 mm (0.197 in.) alphanumeric Helvetica med. Font *1		
Mechanical resolution	0.005mm		
Programmable resolution	GP-GL: 0.1 / 0.05/0.025/0.01mm HP-GL *3: 0.025mm		
Repeatable accuracy *1	0.1 mm or less / in unit of 2 m (Designated Film and Cut Conditions)		
Number of cutters/pens	1 pc.		
Usable pen type	Water-based fiber-tip and oil-based ballpoint		
Compatible media	Mono-vinyl chloride media, fluorescent media, and reflective media up to 0.25 mm thick (Excluding high-intensity reflective film)		
Interface	USB 2.0 (Full Speed), Wireless LAN IEEE 802.11b/g/n, Ethernet 10 BASE-T/100 BASE-TX *5		
Buffer memory	2 MB		
Resident command sets	GP-GL/HP-GL *3 (Control panel switching, Auto switching)		
LCD display	Touch panel (240-dot x 128-dot)		
Power supply	AC100-120V / AC200V-240V 50/60Hz		
Power consumption	140W or less		
Operating environment	10 to 35°C, 35 to 75% R.H. (non-condensing)		
Guaranteed accuracy environment	16 to 32°C, 35 to 70% R.H. (non-condensing)		
External dimensions (Approx.) (W × D × H)	677 × 451 × 266 mm *4	903 × 582 × 1076 mm *4	1644 × 811 × 1076 mm *4
Weight (Approx.)	11 kg *4	21 kg *4	40 kg *4

*1: Varies depending on the type of Graphtec-authorized film and the cutting conditions.

*2: When using basket.

*3: HP-GL is a registered trademark of the US Hewlett Packard Company.

*4: Roll-medium tray or stand is included.

*5: This is an option provided at the factory.

A.2 Options and Supplies

Supplies

Item	Model	Contents
Cutter plunger	PHP33-CB09N-HS	Used with ϕ 0.9 mm diameter cutter blades (for CB09)
	PHP33-CB15N-HS	Used with ϕ 1.5 mm diameter cutter blades (for CB15)
Water-based fiber-tip pen plunger	PHP31-FIBER	Plunger for water-based fiber-tip pen (set of 1)
Oil-based ballpoint pen plunger	PHP34-BALL	Plunger for oil-based fiber-tip pen (set of 1)
Water-based fiber-tip pen	KF700-BK	1 set (10 pcs. Black)
	KF700-RD	1 set (10 pcs. Red)
Oil-based ballpoint pen	KB700-BK	1 set (10 pcs. Black)
Loupe for adjusting blade length for cutter blade	PM-CT-001	1 pc.
Carrier Sheet	CR09300-A3	2 sht. (A3 size)
Cutting mat for CE8000-40	PM-CR-013	1 set
Cutting mat for CE8000-60	PM-CR-014	1 set
Cutting mat for CE8000-130	PM-CR-015	1 set
USB cable	PM-ET-001	1 pc. (cable length: 2.9 m)

For detailed information about the cutter blade, refer to the Cutter Blade Manual.

The Cutter Blade Manual is available at:

<http://www.graphteccorp.com/support/index.html>

Please check our company's home page for the latest information on supplies.

Options

Item	Model	Contents	Quantity
Basket	PG0111	Used with CE8000-60	1 set
	PG0112	Used with CE8000-130	1 set
Roll-medium tray	OPH-A57	Used with CE8000-60	1 set
Carrier Sheet Table	OPH-A45	Used with CE8000-40/60	1 set

Optional items may vary depending on the area. For details, please contact the distributor where you purchased.

Please check our company's home page for the latest information on supplies.

A.3 External Dimensions

CE8000-40

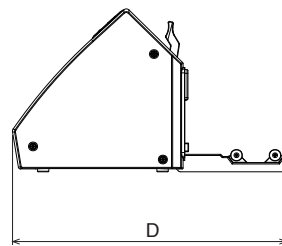
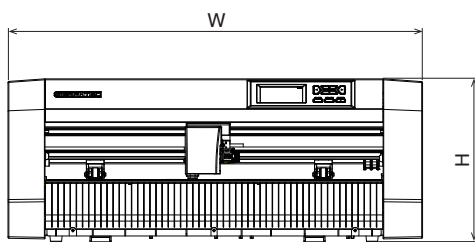
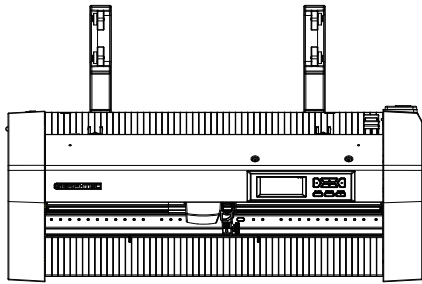

Unit: mm
Dimensional accuracy: ± 5 mm

	CE8000-40
External dimensions (approx.) (W x D x H)	677 x 451 x 266 mm

CE8000-60

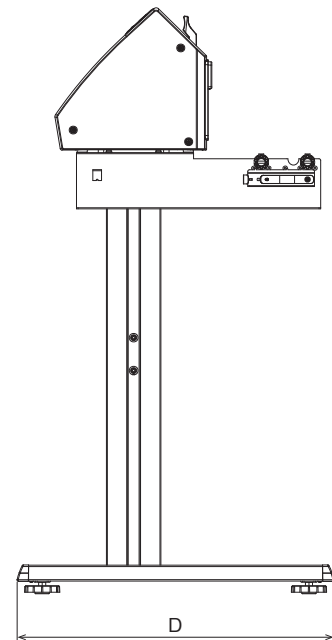
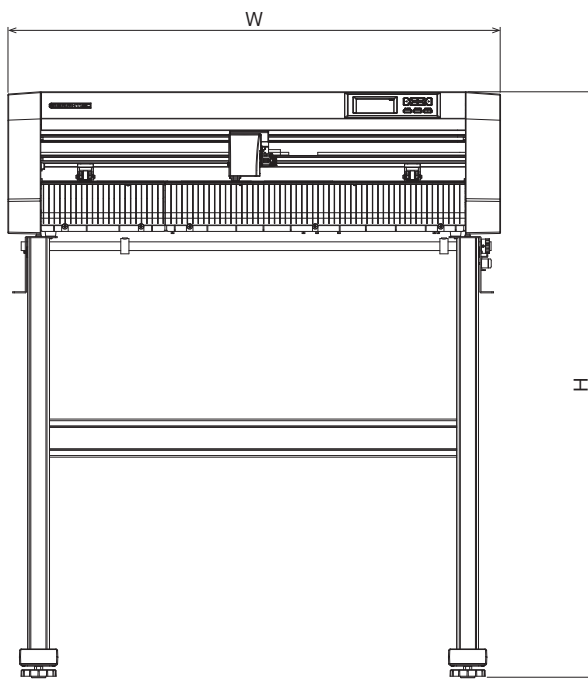
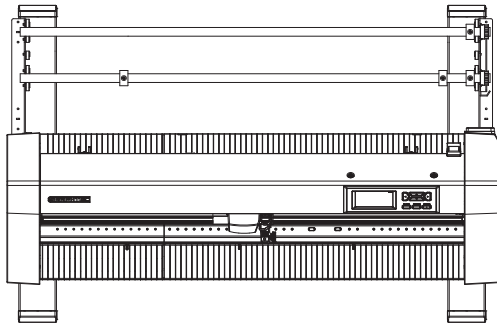

Unit: mm
Dimensional accuracy: ±5mm

	CE8000-60
External dimensions (approx.) (W × D × H)*	903 × 582 × 1076 mm

*: Stand is included.

CE8000-130

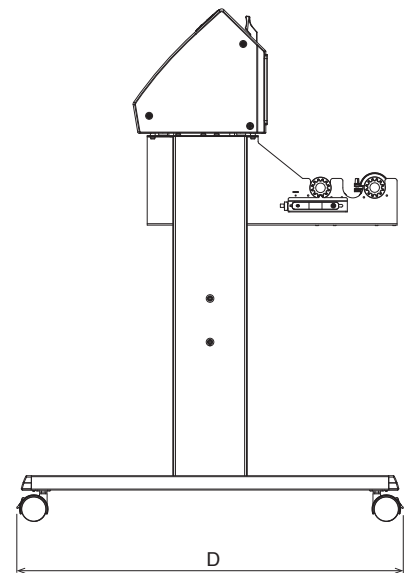
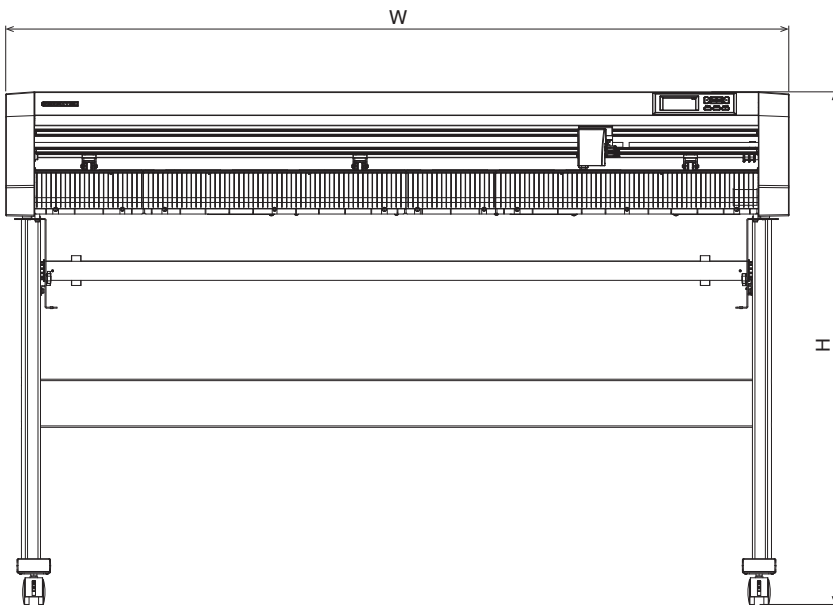
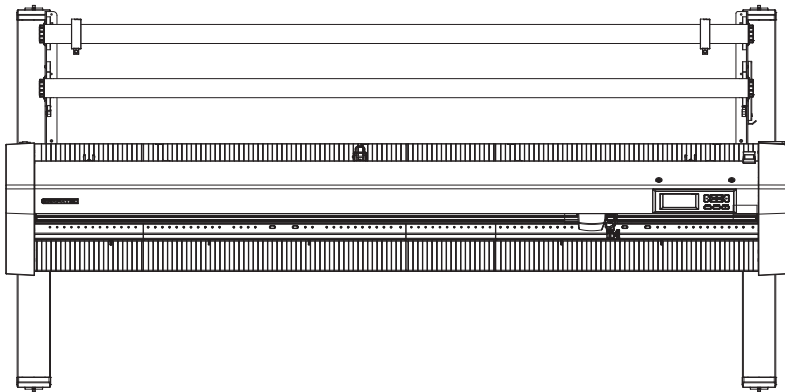

Unit: mm
Dimensional accuracy: ±5mm

	CE8000-130
External dimensions (approx.) (W x D x H)*	1644 x 811 x 1076 mm

*: Stand is included.

A.4 Menu Tree

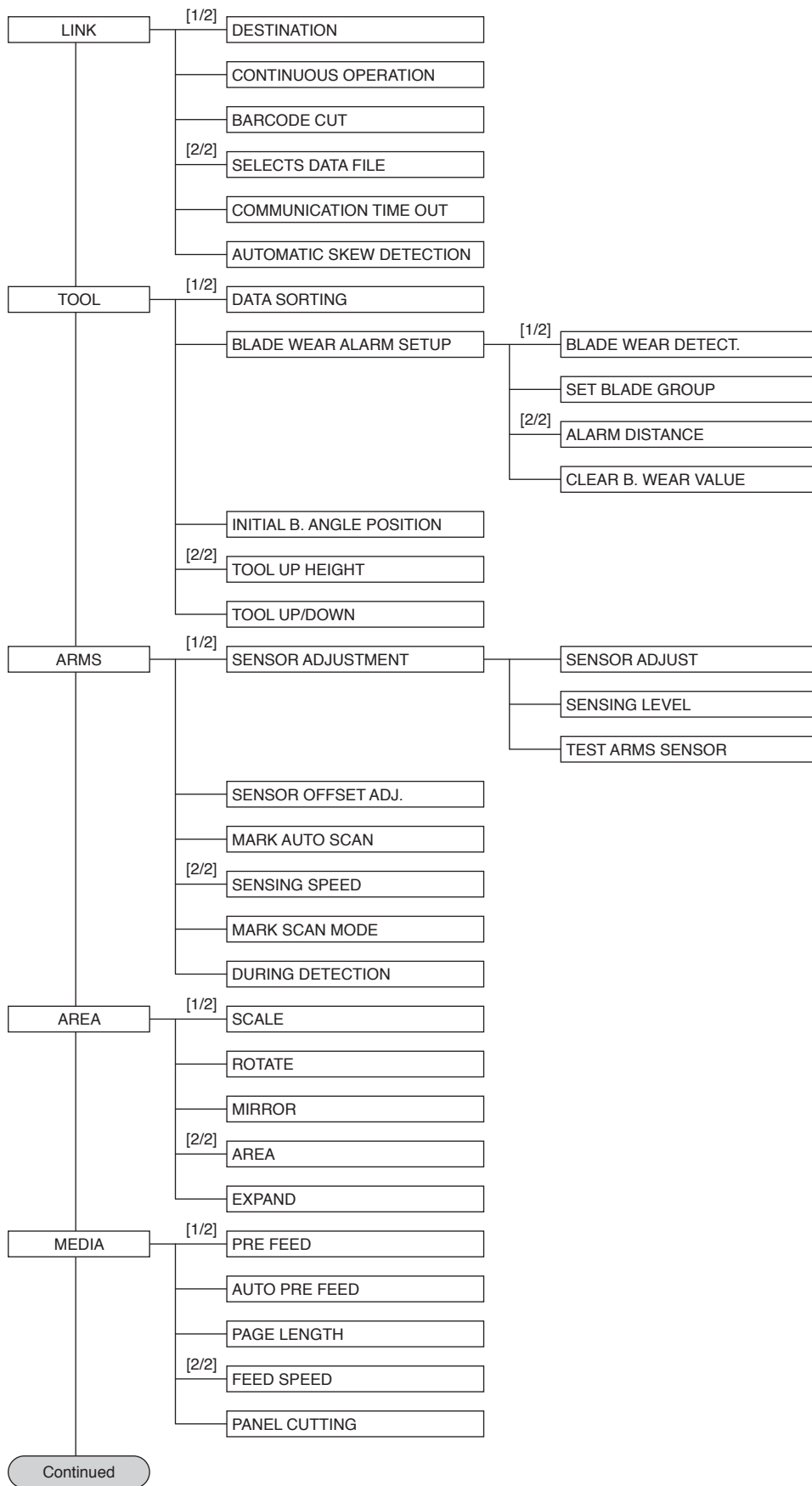

Continued

Continued

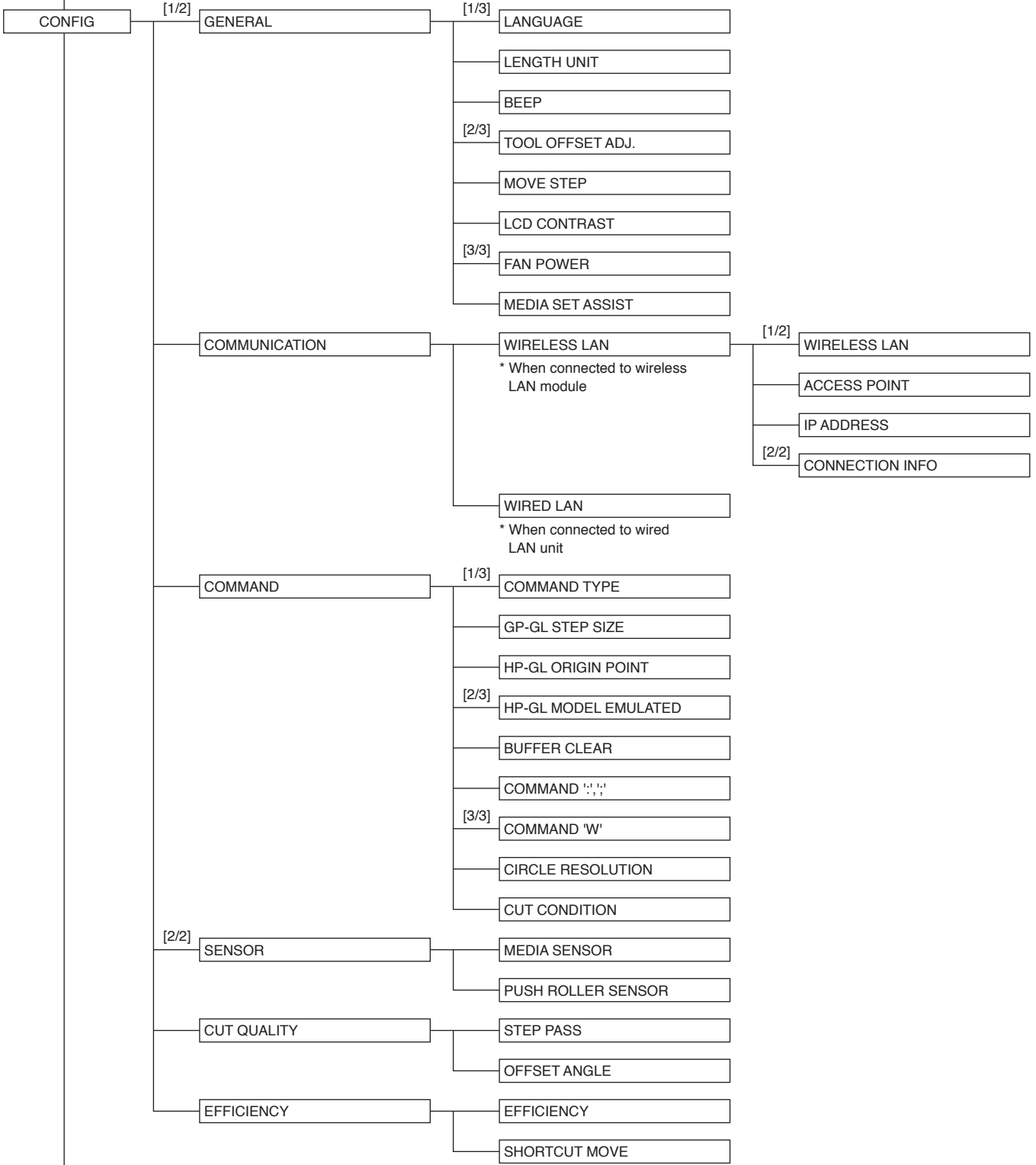

Continued

Continued

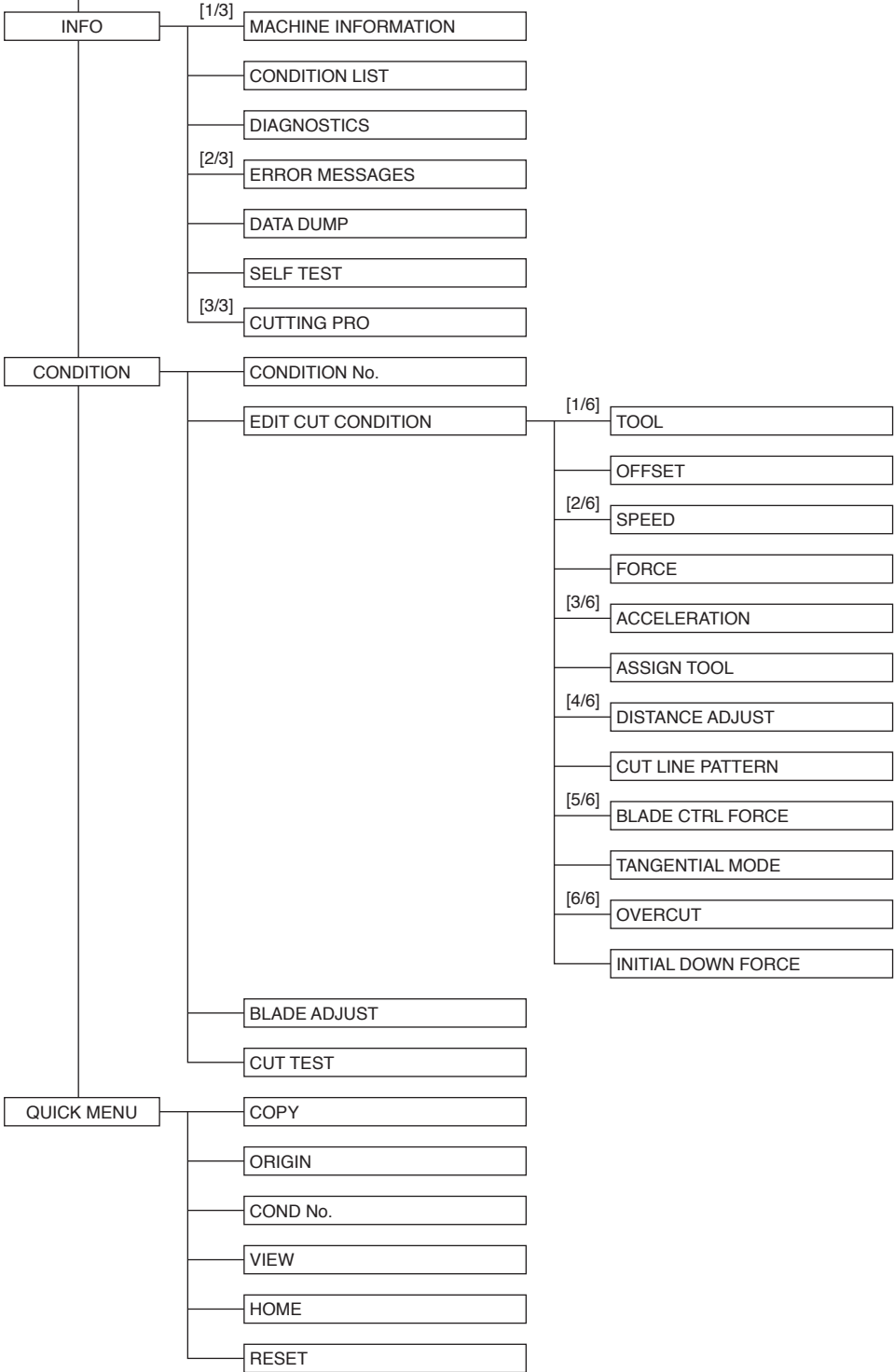

A.5 Initial Setting

Menu items		Setting item	Initial value		
DATA LINK (LINK)		DESTINATION	USB DRIVE		
		COMMUNICATION TIME OUT	10 sec		
		AUTOMATIC SKEW DETECTION	10 mm		
TOOL SETTING (TOOL)		DATA SORTING	OFF		
		BLADE WEAR ALARM SETUP	OFF		
		INITIAL B. ANGLE POSITION	2 mm BELOW		
		TOOL UP HEIGHT	NORMAL		
ARMS SETTING (ARMS)	SENSOR ADJUSTMENT	SENSING LEVEL X	70		
		SENSING LEVEL Y	80		
	SENSOR OFFSET ADJ.	CORRECTION VALUE X	0.0 mm		
		CORRECTION VALUE Y	0.0 mm		
			MARK AUTO SCAN	ON	
			SENSING SPEED	30 cm/s	
			MARK SCAN MODE	OFF	
CUT AREA (AREA)		SCALE	1		
		ROTATE	OFF		
		MIRROR	OFF		
		CUT AREA LOWER LEFT	(Default)		
		CUT AREA UPPER RIGHT	(Default)		
		EXPAND	OFF		
MEDIA SETTING (MEDIA)		PRE FEED	1 m		
		AUTO PRE FEED	OFF		
		FEED LENGTH	1 m		
		PAGE LENGTH	200.0 cm (CE8000-40) 500.0 cm (CE8000-60/130)		
		FEED SPEED	NORMAL		
		PANEL CUTTING	OFF		
		DIVIDE LENGTH	100.0 cm		
CONFIGURATION (CONFIG)	GENERAL	LANGUAGE		(Selected at initial power-on)	
		LENGTH UNIT		(Selected at initial power-on)	
		BEEP		ON	
		TOOL OFFSET ADJ.	CORRECTION VALUE X	0.0 mm	
			CORRECTION VALUE Y	0.0 mm	
		MOVE STEP		0.1 mm	
		LCD CONTRAST		0	
		FAN POWER		NORMAL	
		MEDIA SET ASSIST		ON	
	COMMUNICATION	WIRELESS LAN	WIRELESS LAN		OFF
			IP ADDRESS	DHCP	OFF
				IP ADDRESS	192.168.0.2
				SUBNET MASK	255.255.255.0
		WIRED LAN	DHCP		OFF
			IP ADDRESS		192.168.0.1
			SUBNET MASK		255.255.255.0
			GATEWAY		192.168.0.254
		COMMAND	COMMAND TYPE		AUTO
	GP-GL STEP SIZE		0.100 mm		
	HP-GL ORIGIN POINT		LOWER LEFT		
	HP-GL MODEL EMULATED		7586		
	COMMAND ';;'		ENABLED		
	COMMAND 'W'		TOOL UP		
CIRCLE RESOLUTION			DEFAULT		
CUT CONDITION			COMMAND PRIORITY		

Menu items		Setting item	Initial value	
CONFIGURATION (CONFIG)	SENSOR	MEDIA SENSOR	ENABLED	
		PUSH ROLLER SENSOR	ENABLED	
	CUT QUALITY	STEP PASS	1	
		OFFSET ANGLE	30	
	EFFICIENCY	MOVING SPEED	AUTO	
		SHORTCUT MOVE	ON	
EDIT CUT CONDITION	No.1	MEDIA NAME	Condition No. 1	
		TOOL	CB09U	
		SPEED	30	
		FORCE	14	
		ACCELERATION	2	
		ASSIGN TOOL	1	
		DISTANCE ADJUST	OFF	
		CUT LINE PATTERN	OFF	
		BLADE CTRL FORCE	4	
		TANGENTIAL MODE	OFF	
		OVERCUT	START	0.000
			END	0.000
		INITIAL DOWN FORCE	0	
		No.2	MEDIA NAME	Condition No. 2
	TOOL		PEN	
	SPEED/FORCE/ACCELERATION		30/12/2	
	From ASSIGN TOOL to INITIAL DOWN FORCE		Same as condition 1	
	No.3	MEDIA NAME	Condition No. 3	
		TOOL	CB09U	
		SPEED/FORCE/ACCELERATION	30/12/2	
		From ASSIGN TOOL to INITIAL DOWN FORCE	Same as condition 1	
	No.4	MEDIA NAME	Condition No. 4	
		TOOL	CB09U	
		SPEED/FORCE/ACCELERATION	20/17/1	
		From ASSIGN TOOL to INITIAL DOWN FORCE	Same as condition 1	
	No.5	MEDIA NAME	Condition No. 5	
		TOOL	CB09U	
		SPEED/FORCE/ACCELERATION	60/17/3 (CE8000-40) 64/17/3 (CE8000-60) 71/17/2 (CE8000-130)	
		From ASSIGN TOOL to INITIAL DOWN FORCE	Same as condition 1	
	No.6	MEDIA NAME	Condition No. 6	
		TOOL	CB09U	
		SPEED/FORCE/ACCELERATION	10/22/2	
		From ASSIGN TOOL to INITIAL DOWN FORCE	Same as condition 1	
	No.7	MEDIA NAME	Condition No. 7	
		TOOL	CB09U-K60	
		SPEED/FORCE/ACCELERATION	30/17/2	
		From ASSIGN TOOL to INITIAL DOWN FORCE	Same as condition 1	
	No.8	MEDIA NAME	Condition No. 8	
		TOOL	CB15U	
		SPEED/FORCE/ACCELERATION	5/30/1	
From ASSIGN TOOL to INITIAL DOWN FORCE		Same as condition 1		

* Setting items and initial values may be changed.

Specifications are subject to change without notice.

CE8000 Series User's Manual

CE8000-UM-151

March 31, 2024 1st edition-01

GRAPHTEC CORPORATION

GRAPHTEC